

ROTARY VANES VACUUM PUMP | POMPA A PALETTE PER VUOTO/PRESSIONE

MEC

1000 | 1600 | 2000 | 3000
4000 | 5000 | 6500 | 8000



Battioni®
Pagani

Setting the pace since 1953

MEC 1000 | 1600 | 2000 | 3000 | 4000 | 5000 | 6500 | 8000

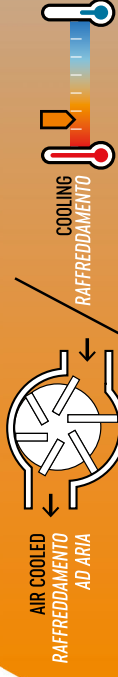

More than 500.000 MEC pumps have been put in operation to empty cesspits and transport slurry in agricultural and industrial applications.

The reliability and strength of the MEC is the result of **continuous design and manufacturing improvements** accomplished during 40 years of deployments.

Più di 500.000 pompe MEC sono utilizzate per pozzi neri, trasporto liquami in applicazioni agricole e industriali. L'affidabilità e la forza delle pompe MEC è il risultato dei **continui miglioramenti progettuali e produttivi** compiuti in 40 anni di implementazioni.



Selector vacuum - pressure/
Selettore Vuoto - Pressione

Predisposition for overpressure valve/
Predisposizione per valvola di sovrappressione

Forced lubrication pump as standard (automatic lubrication on request)/Pompa di lubrificazione forzata di serie (lubrificazione automatica a richiesta)

Non-return check valve as standard/
Valvola di non ritorno di serie

Blades inspection hole/
Foro ispezione palette

High wearing resistance thanks to cast-iron with high hardness/
Elevata resistenza ad usura grazie a ghisa ad alta durezza

Long life blades on request/
Palette Long Life resistenti al calore a richiesta

The picture is only for informative purposes. | The picture is only for informative purposes.



Battioni®
Pagani

Setting the pace since 1953

VERSIONS | VERSIONI

MEC 1000 1600

MEC/M

Splined shaft / Albero scanalato:
1"3/8 - Z6 ISO 500

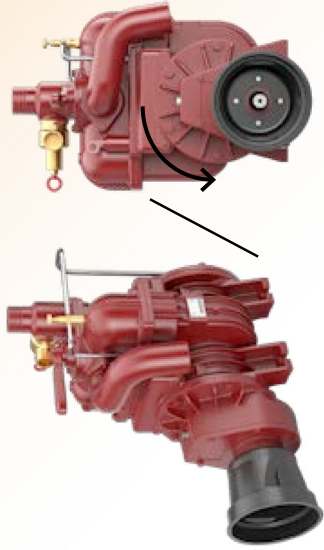

CCW as standard / CCW di serie

MEC/P

Smooth cylindrical shaft / Albero cilindrico liscio: Ø 22
Length / Lunghezza: 48 mm
Parallel key / Chiave parallela: UNI 6604

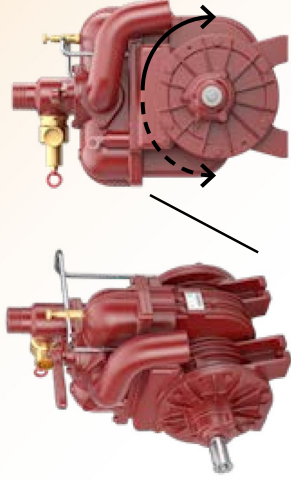

CW as standard - CCW on request / CW di serie - CCW su richiesta

MEC/H

MEC 1000: Group 2 21,14 cc/rev • Pmax 200 bar • In 6 1/2" • Out 6 3/4"
Group 2 40 cc/rev • Pmax 175 bar • In 6 1/2" • Out 6 1/2"
MEC 1600: Group 2 21,14 cc/rev • Pmax 200 bar • In 6 1/2" • Out 6 3/4"
Group 2 40 cc/rev • Pmax 175 bar • In 6 1/2" • Out 6 1/2"

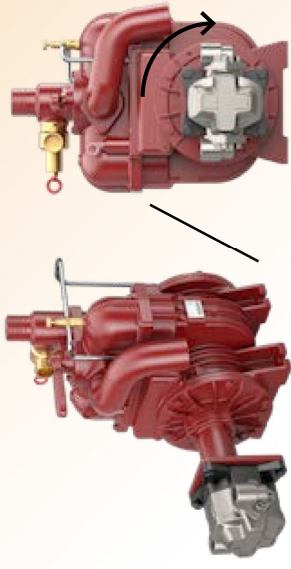

CW as standard / CW di serie

Its light and compact design made MEC 1000/1600 the best vacuum pump for portable sanitation services and small vacuum tank for liquid applications.

Il design leggero e compatto ha reso MEC 1000/1600 la migliore pompa per vuoto per servizi igienici portatili e piccoli serbatoi per applicazioni con liquidi.

STANDARD FEATURES | CARATTERISTICHE STANDARD

- 4-ways valve, non-return check valve
- Available hoses connections:
Ø 27 mm / Ø 45 mm / G 1" / G 1" 1/4
- Thread for Overpressure valve: Not available
- Valvola a 4 vie, valvola di non ritorno
- Collegamenti tubi disponibili:
Ø 27 mm / Ø 45 mm / G 1" / G 1" 1/4
- Filettatura per valvola di sovrappressione: non disponibile



**Battioni®
Pagani**

Setting the pace since 1953

OPTIONALS | OPZIONALI



**LONG LIFE
BLADES/
PALETTE
'LONG LIFE'**



**AUTOMATIC
LUBRICATION/
LUBRIFICAZIONE
AUTOMATICA**
▶ Single lubrication point/
Punto di lubrificazione
singolo



**REVOLVING
ELBOW/
GOMITO
GIREVOLE**
Ø 45 mm



**CUSTOMIZED
PAINTING**
COLORI PERSONALIZZATI



**BATTIONI PAGANI
VACUUM PUMP OIL/
BATTIONI PAGANI
VACUUM PUMP OIL**
5 Lt

▶ Code/Codice: 5070200100



**BATTIONI PAGANI
FLUSHING FLUID/
BATTIONI PAGANI
FLUSHING FLUID**
5 Lt

▶ Code/Codice: 5070200102



**FLUSHING KIT/
FLUSHING KIT**

▶ Code/Codice: 6080200325

PUMP ACTIVE CONTROLLER

Electronic device designed to monitor the operating conditions of the pump.
Dispositivo elettronico per regolazione e il monitoraggio delle condizioni di funzionamento della pompa.



Data storage on Cloud/Archivio dei dati su Cloud

Main functions:

- ▶ Setting discharge pressure during emptying operations
- ▶ Constant monitoring and recording of pump data parameters
- ▶ Automatic washing of pump's rotors
- ▶ Automatic protection against overheating of the pump

Principali funzioni:

- ▶ Regolazione della pressione di scarico durante lo svuotamento della cisterna
- ▶ Costante controllo e registrazione dei parametri di funzionamento
- ▶ Lavaggio dei rotori automatico
- ▶ Protezione contro surriscaldamento della pompa



▶ USB port/
Porta USB



▶ GPRS and
modem/GPRS
e modem



**Battioni®
Pagani**

Setting the pace since 1953

ACCESSORIES

| ACCESSORI

ROTARY VANES VACUUM PUMP / POMPA A PALETTE PER VUOTO / PRESSIONE

MEC 1000 1600

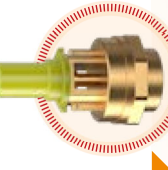
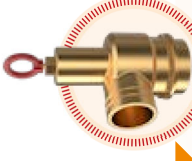
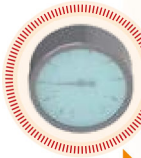

4A
GAUGE AXIAL CONNECTION/MANOMETRO CON ATTACCO ASSIALE
Ø80 mm
Code/Codice: 510700007
To be fitted on secondary valve/
Da montare sulla valvola secondaria

4B
DISCHARGE VALVE/ VALVOLA DI SCARICO
3/4"
Code/Codice: 504020006
To be fitted on secondary valve/
Da montare sulla valvola secondaria

5
FILTER SILENCER/ SILENZIATORE FILTRO
Code/Codice: 5509000110
Hose connection/Giunzione del tubo: ø 45 mm
Weight/Pesc: 2,5 Kg

6
SLIDING SUPPORT/ SUPPORTO SCORREVOLE
Ø165 mm
Code/Codice: 5090000138
Silencer/Silenziatore: 5090000110

7
RAIN CAP/ RAIN CAP
Ø45 mm
Code/Codice: 5090000111
(for filter-silencer only/
solo per filtro-silenziatore)

1
VACUUM RELIEF VALVE/ VALVOLA LIMITATRICE DI VUOTO
1"1/2
Code/Codice: 5100200012
Setting range/Settinggio: -0,3 bar/+0,8 bar
Working temperature/ Temperatura di lavoro: -20°C/+90°C
Thread/Filetto: G 1"1/2
Weight/Pesc: 0,65 Kg

2
OVERPRESSURE SAFETY VALVE/VALVOLA DI SICUREZZA PER SOVRAPRESSIONE
1"1/4
Code/Codice: 5100200009
Setting range/Settinggio: +0,3 bar/+1,5 bar
Working temperature/ Temperatura di lavoro: -20°C/+90°C
Thread/Filetto: G 1"1/4
Weight/Pesc: 0,94 Kg

3
PRIMARY OVERFLOW VALVE-SINGLE RUBBER BALL/VALVOLA DI TROPPO PIENO PRIMARIA-SFERA DI GOMMA SINGOLA
Ø45 mm
Code/Codice: 6100200006
Weight iron ring to be welded/
Peso anello in ferro da saldare: 4,5 Kg

4
SECONDARY VALVE - SINGLE RUBBER BALL/ VALVOLA DI TROPPO PIENO SECONDARIA-GOMMA SINGOLA
Ø45 mm
Code/Codice: 6100200003
Weight/Pesc: 17,5 Kg



**Battioni®
Pagani**

Setting the pace since 1953

VERSIONS | VERSIONI

ROTARY VAINES VACUUM PUMP / POMPA A PALETTE PER VUOTO / PRESSIONE

MEC 2000 3000 4000

MEC/M

Splined shaft / Albero scanalato:
1"3/8 - Z6 ISO 500

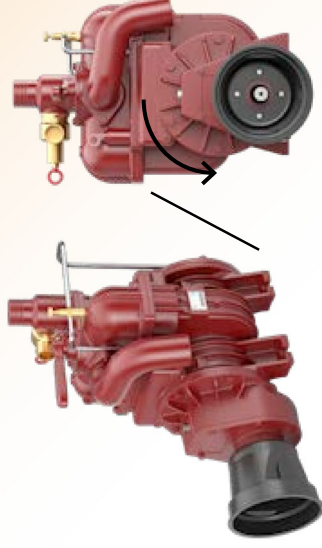

CCW as standard / CCW di serie

MEC/P

Smooth Cylindrical shaft / Albero cilindrico liscio: Ø 30
Length / Lunghezza: 50 mm
Parallel key / Chiave parallela: UNI 6604

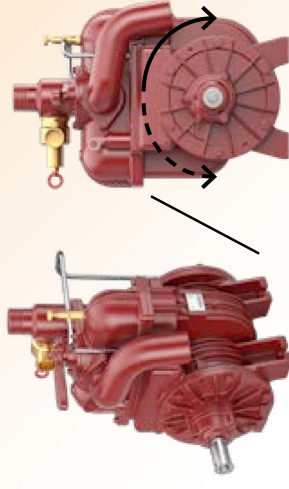

CW as standard - CCW on request / CW di serie - CCW su richiesta

STANDARD FEATURES | CARATTERISTICHE STANDARD

- ▶ Forced lubrication, 4-ways valve, non-return check valve
- ▶ Available hoses connections: Ø 45 mm / Ø 60 mm / G 2"
- ▶ Thread for Overpressure valve: G 1"1/4
- ▶ Lubrificazione forzata, Valvola a 4 vie, valvola di ritegno
- ▶ Collegamenti tubi disponibili: Ø 45 mm / Ø 60 mm / G 2"
- ▶ Filettatura per valvola di sovrappressione: G 1"1/4



**Battioni®
Pagani**

Setting the pace since 1953

VERSIONS | VERSIONI

ROTARY VANES VACUUM PUMP / POMPA A PALETTE PER VUOTO / PRESSIONE

MEC 2000 | 3000 | 4000

MEC/D

Splined shaft / Albero scanalato:
1"3/8 - Z6 ISO 500

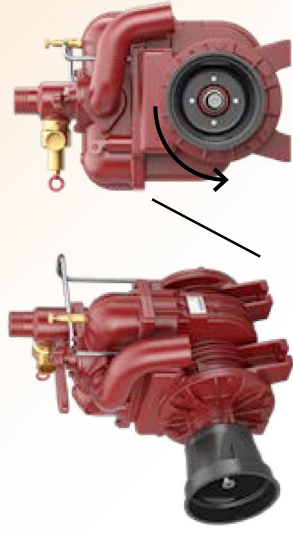

CCW as standard / CCW di serie

MEC/HM

100 cc/rev
Pmax 175 bar
In 6 1/2"
Out 6 1/2"

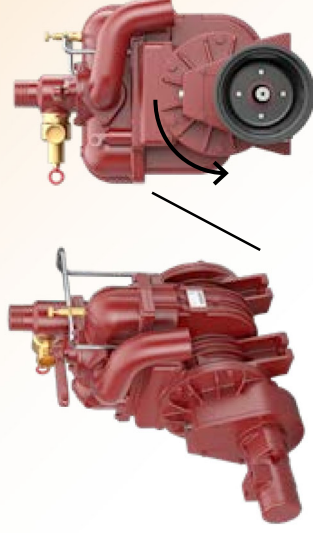

CCW as standard / CCW di serie

MEC/H

MEC 2000: Group 3 26.7 cc/rev • Pmax 280 bar • In 6 1" • Out 6 3/4"
MEC 3000: Group 3 26.7 cc/rev • Pmax 280 bar • In 6 1" • Out 6 3/4"
MEC 4000: Group 3.5 43.98 cc/rev • Pmax 250 bar • In 6 1" • Out 6 1"

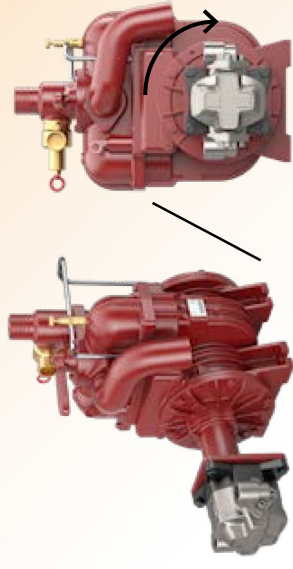

CW as standard / CW di serie



**Battioni®
Pagani**

Setting the pace since 1953

OPTIONALS | OPZIONALI

MEC 2000 3000 4000

PUMP ACTIVE CONTROLLER



Data storage on Cloud / Archivio dei dati su Cloud



PNEUMATIC REVOLVING CHANGEOVER/
CAMBIO PNEUMATICO GIREVOLE
Code / Codice: 6080200160



HYDRAULIC CHANGEOVER/
CAMBIO IDRAULICO
Code / Codice: 6080200217



KIT VACUUM RELIEF VALVE FOR REVOLVING ELBOW/
KIT VALVOLA LIMITATRICE DI VUOTO PER GOMITO GIREVOLE
Code / Codice: 6080200390



REVOLVING ELBOW/
GOMITO GIREVOLE
Ø45 mm
Ø51 mm
Ø60 mm

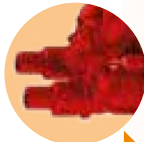

DOUBLE OUTLET/
DOPPIA USCITA
Ø60 mm

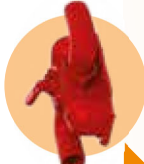

SIDE OUTLET/
USCITA LATERALE
With two revolving elbows/ Con due gomiti girevoli



AUTOMATIC LUBRICATION/
LUBRIFICAZIONE AUTOMATICA
Single lubrication point/ Punto di lubrificazione singolo

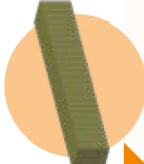

LONG LIFE BLADES/
PALETTE 'LONG LIFE'

Electronic device designed to monitor the operating conditions of the pump. / Dispositivo elettronico per regolazione e il monitoraggio delle condizioni di funzionamento della pompa.

Main functions:

- ▶ Setting discharge pressure during emptying operations
- ▶ Constant monitoring and recording of pump data parameters
- ▶ Automatic washing of pump's rotors
- ▶ Automatic protection against overheating of the pump

Principali funzioni:

- ▶ Regolazione della pressione di scarico durante lo svuotamento della cisterna
- ▶ Costante controllo e registrazione dei parametri di funzionamento
- ▶ Lavaggio dei rotori automatico
- ▶ Protezione contro surriscaldamento della pompa



▶ **USB port/**
Porta USB



▶ **GPRS and modem/**
GPRS e modem

CUSTOMIZED PAINTING COLORI PERSONALIZZATI



BATTIONI PAGANI FLUSHING FLUID/
BATTIONI PAGANI FLUSHING FLUID
5 Lt
Code / Codice: 5070200102



BATTIONI PAGANI VACUUM PUMP OIL/
BATTIONI PAGANI VACUUM PUMP OIL
5 Lt
Code / Codice: 5070200100



FLUSHING KIT/
FLUSHING KIT
Code / Codice: 6080200325



KIT ALUMINUM FINAL AIR FILTER 500 SELF CLEANING/
FILTRO ASPIRAZIONE ARIA COMPLETO COLLETTORE 500
Code / Codice: 6080200507



KIT VALVES AND MANOMETER TREE U.L./
KIT VALVOLE E ALBERO MANOMETRO U.L.
Code / Codice: 6080200488

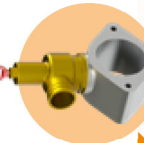

KIT OVERPRESSURE/
KIT SOVRAPRESSIONE 1" 1/4
Code / Codice: 6080200391
Safety valve for revolving elbow/ Valvola di sicurezza per gomito girevole



KIT VALVES AND MANOMETER TREE/
KIT VALVOLE E ALBERO MANOMETRO 1" 1/4
Code / Codice: 6080200391



**Battioni®
Pagani**

Setting the pace since 1953

ACCESSORIES | ACCESSORI

ROTARY VANES VACUUM PUMP / POMPA A PALETTE PER VUOTO / PRESSIONE

MEC 2000 3000 4000

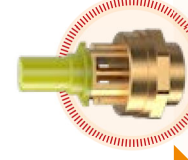
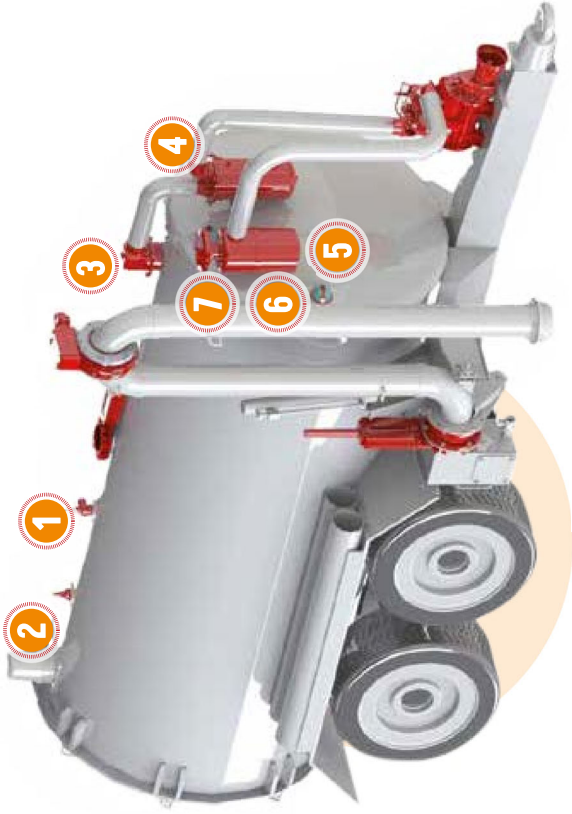

1
**VACUUM RELIEF VALVE/
VALVOLA LIMITATRICE
DI VUOTO
1"1/2**
Code / Codice: 5100200012
Setting range / Settaggio:
-0,3 bar / +0,8 bar
Working temperature /
Temperatura di lavoro:
-20°C / +90°C
Thread / Filetto: 6 1"1/2
Weight / Peso: 0,65 Kg

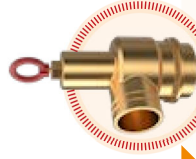

2
**OVERPRESSURE
SAFETY VALVE / VALVOLA
DI SICUREZZA PER
SOVRAPRESSIONE 1"1/4**
Code / Codice: 5100200009
Setting range / Settaggio:
+0,3 bar / +1,5 bar
Working temperature /
Temperatura di lavoro:
-20°C / +90°C
Thread / Filetto: 6 1"1/4
Weight / Peso: 0,94 Kg



3
**PRIMARY OVERFLOW
VALVE - SINGLE RUBBER
BALL / VALVOLA DI TROPPO
PIENO PRIMARIA -
GOMMA SINGOLA**
Code / Codice: 6100200006
Ø45: 6100200006
Ø60: 6100200007
Weight iron ring to be welded /
Peso anello in ferro da saldare:
4,5 Kg



4
**SECONDARY VALVE -
SINGLE RUBBER BALL/
VALVOLA DI TROPPO
PIENO SECONDARIA -
GOMMA SINGOLA**
Code / Codice: 6100200003
Ø60: 6100200004
Weight / Peso: 17,5 Kg

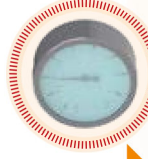

4A
**GAUGE AXIAL
CONNECTION / MANOMETRO
CON ATTACCO ASSIALE
Ø80 mm**
Code / Codice: 5107000007
To be fitted on secondary valve /
Da montare sulla valvola secondaria



4B
**DISCHARGE VALVE/
VALVOLA DI SCARICO
3/4"**
Code / Codice: 5040200006
To be fitted on secondary valve /
Da montare sulla valvola secondaria



5
**FILTER SILENCER/
SILENZIATORE FILTRO**
Code / Codice: 5090000110
MEC 2000-Ø45: 5090000110
MEC 3000/4000-Ø60:
5090000083
Weight / Peso: 3,9 Kg

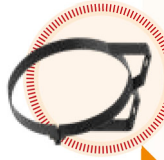

6
**SLIDING SUPPORT/
SUPPORTO SCORREVOLE**
Code / Codice: 5090000138
Silencer / Silenziatore: 5090000110
Ø165: 5090000138
Ø187: 5090000139
Silencer / Silenziatore: 5090000083

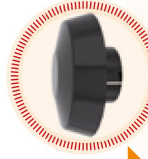

7A
RAIN CAP / RAIN CAP
Code / Codice: 5090000111
MEC 2000-Ø45: 5090000111
MEC 3000/4000-Ø60:
5090000060
(for filter-silencer only /
solo per filtro-silenziatore)

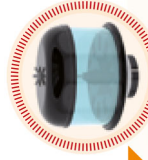

7A
**PRE-FILTER/
PRE-FILTER**
Code / Codice: 5090000045
MEC 3000/4000-Ø 60:
5090000045
(for filter-silencer only /
solo per filtro-silenziatore)



**Battioni®
Pagani**
Setting the pace since 1953

VERSIONS | VERSIONI

ROTARY VANES VACUUM PUMP / POMPA A PALETTE PER VUOTO / PRESSIONE

MEC 5000 6500 8000

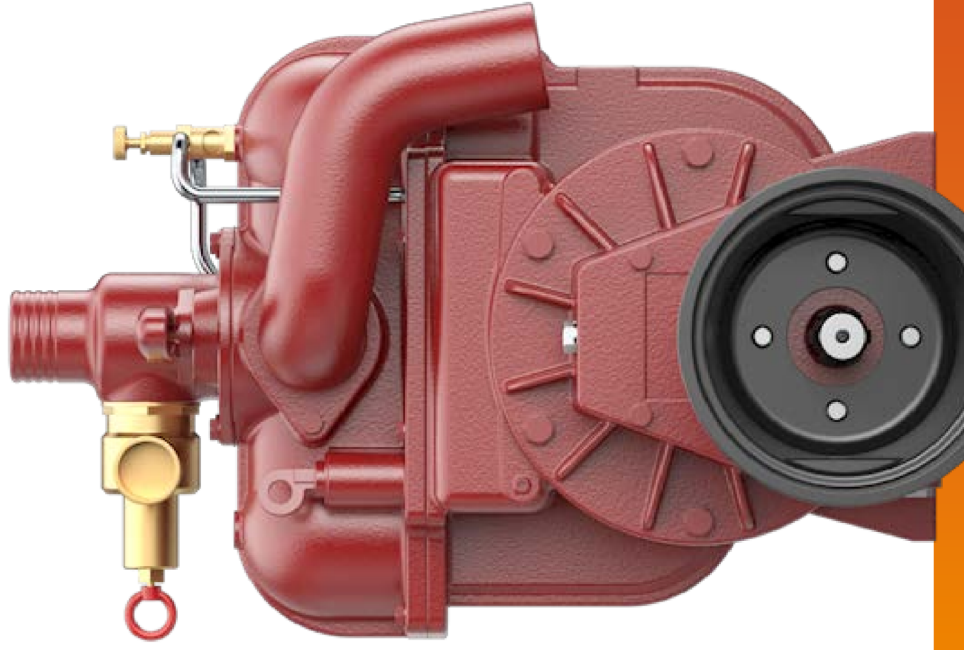

MEC/M

Spined shaft/Albero scanalato:
1"3/8 - 26 ISO 500

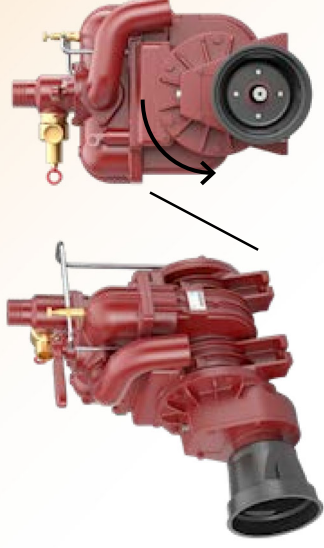

CCW as standard / CCW di serie

MEC/P

Smooth cylindrical shaft/Albero cilindrico liscio: Ø 32
Length/Lunghezza: 70 mm
Parallel key/Chiave parallela: UNI 6604

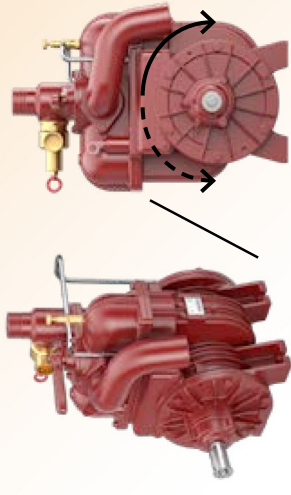

CW as standard - CCW on request / CW di serie - CCW su richiesta

STANDARD FEATURES | CARATTERISTICHE STANDARD

- ▶ Forced lubrication, 4-ways valve, check valve
- ▶ Thread for Overpressure valve: G 1"1/2
- ▶ Available hoses connections: Ø60 mm/Ø76 mm/Ø80 mm

- ▶ Lubrificazione forzata, Valvola a 4 vie, valvola di ritegno
- ▶ Filettatura per valvola di sovrappressione: G 1"1/2
- ▶ Collegamenti tubi disponibili: Ø60 mm/Ø76 mm/Ø80 mm



**Battioni®
Pagani**

Setting the pace since 1953

VERSIONS | VERSIONI

ROTARY VAINES VACUUM PUMP / POMPA A PALETTE PER VUOTO / PRESSIONE

MEC 5000 6500 8000

MEC/D

Splined shaft / Albero scanalato:
1"3/8 - Z6 ISO 500

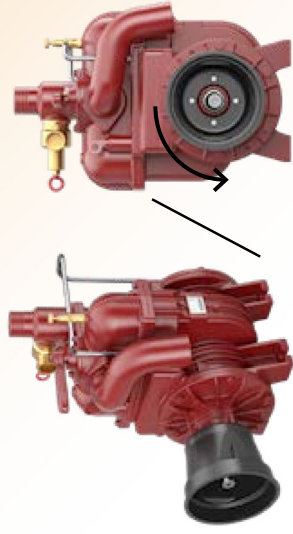

CCW as standard / CCW di serie

MEC/HM

100 cc/rev
Pmax 175 bar
In G 1/2"
Out G 1/2"

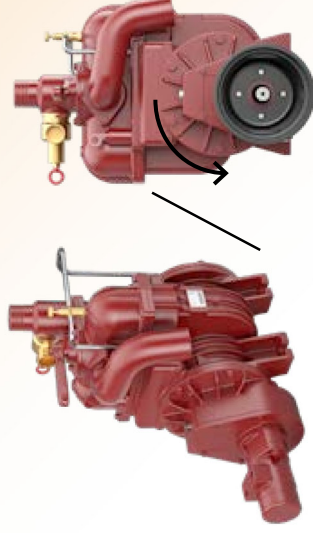

CCW as standard / CCW di serie

MEC/H

MEC 5000: Group 3,5 43,98 cc/rev • Pmax 250 bar • In G 1" • Out G 1"
MEC 6500: Group 3,5 43,98 cc/rev • Pmax 250 bar • In G 1" • Out G 1"
MEC 8000: Group 3,5 51,83 cc/rev • Pmax 230 bar • In G 1" • Out G 1"

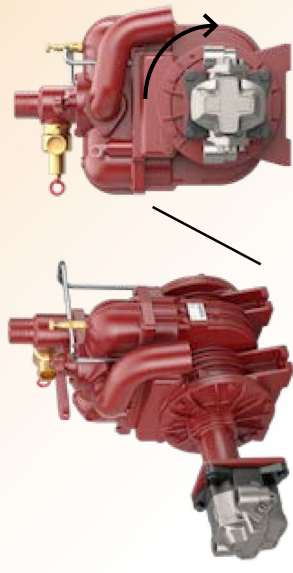

CW as standard / CW di serie



**Battioni®
Pagani**

Setting the pace since 1953

OPTIONALS | OPZIONALI

MEC 5000 6500 8000

PUMP ACTIVE CONTROLLER



Data storage on Cloud / Archivio dei dati su Cloud

Electronic device designed to monitor the operating conditions of the pump. / Dispositivo elettronico per regolazione e il monitoraggio delle condizioni di funzionamento della pompa.

Main functions:

- ▶ Setting discharge pressure during emptying operations
- ▶ Constant monitoring and recording of pump data parameters
- ▶ Automatic washing of pump's rotors
- ▶ Automatic protection against overheating of the pump

Principali funzioni:

- ▶ Regolazione della pressione di scarico durante lo svuotamento della cisterna
- ▶ Costante controllo e registrazione dei parametri di funzionamento
- ▶ Lavaggio dei rotori automatico
- ▶ Protezione contro l'urriscaldamento della pompa



▶ **USB port /**
Porta USB



▶ **GPRS and modem /**
GPRS e modem



**Battioni®
Pagani**

Setting the pace since 1953



**LONG LIFE
BLADES/
PALETTE
'LONG LIFE'**

**AUTOMATIC
LUBRICATION/
LUBRIFICAZIONE
AUTOMATICA**

▶ **MEC 5000:**
Single lubrication
point / Punto di
lubrificazione singolo

▶ **MEC 6500/8000:**
Double lubrication
point / Punto di
lubrificazione doppio



**SIDE
OUTLET/
USCITA
LATERALE**

▶ **With two
revolving elbows /
Con due gomiti
girevoli**



**DOUBLE
OUTLET/
DOPPIA
USCITA**

Ø60 mm



**REVOLVING
ELBOW/
GOMITO
GIREVOLE**

**Ø60 mm
Ø76 mm (3")
Ø80 mm**



**KIT VACUUM
RELIEF VALVE
FOR REVOLVING
ELBOW/
KIT VALVOLA
LIMITATRICE DI
VUOTO PER GOMITO
GIREVOLE**

▶ **Code / Codice:**
6080200486



**HYDRAULIC
CHANGEOVER/
CAMBIO
IDRAULICO**

▶ **Code / Codice:**
6080200175



**PNEUMATIC
REVOLVING
CHANGEOVER/
CAMBIO
PNEUMATICO
GIREVOLE**

▶ **Code / Codice:**
6080200114



**KIT VALVES AND
MANOMETER
TREE/
KIT VALVOLE
E ALBERO
MANOMETRO**

▶ **Code / Codice:**
6080200392



**KIT ALUMINUM
FINAL AIR FILTER
500 SELF
CLEANING/
FILTRO
ASPIRAZIONE ARIA
COMPLETO
COLLETTORE 500**

▶ **Code / Codice:**
6080200363



**HYDRAULIC
REVOLVING
CHANGEOVER/
CAMBIO IDRAULICO
GIREVOLE**

▶ **Code / Codice:**
5090000073



**PNEUMATIC
REVOLVING
CHANGEOVER-
3 POSITIONS/
CAMBIO
PNEUMATICO
GIREVOLE-
3 POSIZIONI**

▶ **Code / Codice:**
6080200292



**FLUSHING KIT/
FLUSHING KIT**

▶ **Code / Codice:**
6080200325



**BATTIONI PAGANI
VACUUM
PUMP OIL/
BATTIONI PAGANI
VACUUM PUMP OIL**

5 Lt
▶ **Code / Codice:**
5070200100



**BATTIONI PAGANI
FLUSHING FLUID/
BATTIONI PAGANI
FLUSHING FLUID**

5 Lt
▶ **Code / Codice:**
5070200102



**EXTRA SIDE
TANK/
SERBATOIO
LATERALE EXTRA**

▶ **Codes / Codice:**
LA: 6080200418
LF: 6080200417

ACCESSORIES

| ACCESSORI

ROTARY VANES VACUUM PUMP / POMPA A PALETTE PER VUOTO / PRESSIONE

MEC 5000 6500 8000

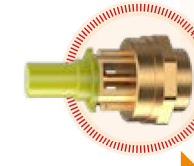
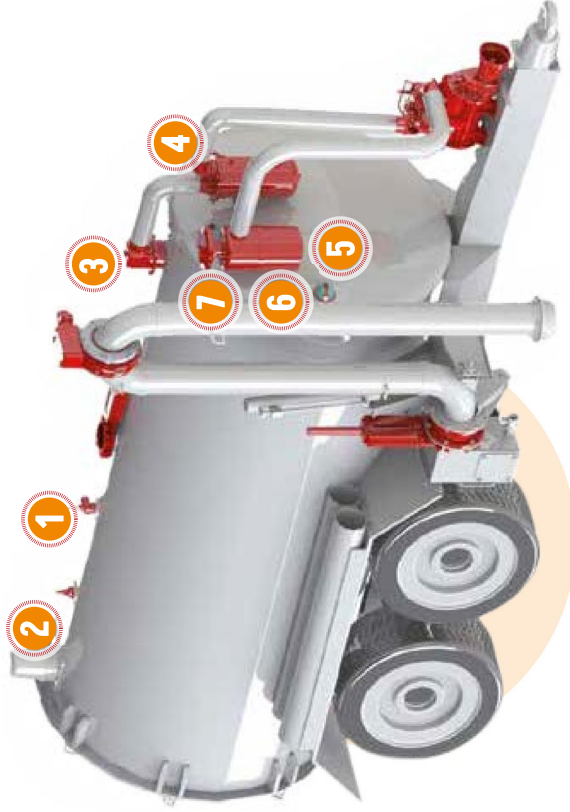

1
**VACUUM RELIEF VALVE/
VALVOLA LIMITATRICE
DI VUOTO
1"1/2**

▶ **Code / Codice:** 5100200012
Setting range / Settaggio:
-0,3 bar / -0,8 bar
**Working temperature /
Temperatura di lavoro:**
-20°C / +90°C
Thread / Filetto: 6 1/2
Weight / Peso: 0,65 Kg

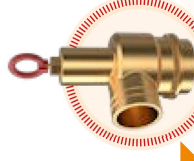

2
**OVERPRESSURE
SAFETY VALVE / VALVOLA
DI SICUREZZA PER
SOVRAPRESSIONE 1"1/2**

▶ **Code / Codice:** 5100200010
Setting range / Settaggio:
+0,3 bar / +1,5 bar
**Working temperature /
Temperatura di lavoro:**
-20°C / +90°C
Thread / Filetto: 6 1/2
Weight / Peso: 1,02 Kg



3
**PRIMARY OVERFLOW
VALVE - SINGLE RUBBER
BALL / VALVOLA DI TROPPO
PIENO PRIMARIA -
SFERA DI
GOMMA SINGOLA**

▶ **Codes / Codici:**
Ø60: 6100200007
Ø80: 6100200008
**Weight iron ring to be welded /
Peso anello in ferro da saldare:**
4,7 Kg / 9,6 Kg



4
**SECONDARY VALVE -
SINGLE RUBBER BALL/
VALVOLA DI TROPPO
PIENO SECONDARIA -
SFERA DI
GOMMA SINGOLA**

▶ **Codes / Codici:**
Ø60: 6100200004
Ø80: 6100200005
Weight / Peso: 18,5 Kg / 20,5 Kg

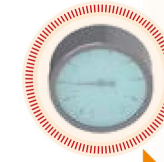

4A
**GAUGE AXIAL
CONNECTION / MANOMETRO
CON ATTACCO ASSIALE
Ø80 mm**

▶ **Code / Codice:** 5107000007
**To be fitted on secondary valve /
Da montare sulla valvola secondaria**

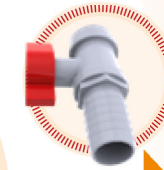

4B
**DISCHARGE VALVE/
VALVOLA DI SCARICO
3/4"**

▶ **Code / Codice:** 5040200006
**To be fitted on secondary valve /
Da montare sulla valvola secondaria**



5
**FILTER SILENCER/
SILENZIATORE FILTRO**

▶ **Codes / Codici:**
MEC 5000-Ø60: 5090000083
MEC 6500/8000-Ø80:
5090000044
Weight / Peso: 7 kg (9,9 lb)

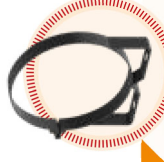

6
**SLIDING SUPPORT/
SUPPORTO SCORREVOLE
Ø187 mm**

▶ **Code / Codice:** 5090000139
Silencer / Silenziatore: 5090000083



7A
RAIN CAP / RAIN CAP

▶ **Codes / Codici:**
MEC 5000-Ø60: 5090000060
MEC 6500/8000-Ø80:
5090000061
**(for filter-silencer only /
solo per filtro-silenziatore)**

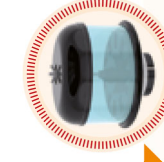

7A
PRE-FILTER / PRE-FILTER

▶ **Codes / Codici:**
MEC 5000-Ø60: 5090000045
MEC 6500/8000-Ø80:
5090000046
**(for filter-silencer only /
solo per filtro-silenziatore)**



**Battioni®
Pagani**

Setting the pace since 1953

TECHNICAL DATA | DATI TECNICI

MEC 1000 | 1600 | 2000 | 3000 | 4000 | 5000 | 6500 | 8000

MODELS MODELLI	GEOMETRICAL CAPACITY GEOMETRICAL CAPACITY		MAX RPM MAX RPM				MAX PRESSURE ABS PRESSIONE ABS Bar (PSI)	MAX VACUUM % MAX VACUUM % inHg	MAX CONTINUOUS VACUUM % MAX CONTINUOUS VACUUM % inHg	POWER AT MAX VACUUM POWER AT MAX VACUUM kW (hp)	WEIGHT/PESO Kg				
	m ³ /h	l/min	cfm	M	P	D					H	HM			
MEC 1000	75,6	1260	45	600	1400	1400	2,5 (36)	89% (26,3")	60% (18")	3,5 (4,7)	40	34	/	48	/
MEC 1600	118,8	1980	70	600	1400	1400	2,5 (36)	89% (26,3")	60% (18")	4,5 (6)	48	42	/	56	/
MEC 2000	165	2750	97	600	1400	1400	2,5 (36)	91% (27,0")	60% (18")	5,5 (7,3)	75	65	65	81	77
MEC 3000	216	3600	127	600	1400	1400	2,5 (36)	92% (27,2")	60% (18")	7 (9,4)	86	75	77	92	89
MEC 4000	261	4350	154	600	1400	1400	2,5 (36)	94% (28,0")	60% (18")	9 (12,6)	97	85	90	116	102
MEC 5000	369	6150	217	600	1400	1400	2,5 (36)	94% (28,0")	60% (18")	11 (14,7)	127	120	121	136	132
MEC 6500	420	7000	247	600	1400	1400	2,5 (36)	94% (28,0")	60% (18")	12,5 (16,7)	142	129	130	154	150
MEC 8000	486	8100	286	600	1400	1400	2,5 (36)	94% (28,0")	60% (18")	16 (21,4)	157	140	141	174	162



**Battioni®
Pagani**
Setting the pace since 1953

PRODUCT COMPLIANCE INFORMATION

Battioni Pagani® vacuum / pressure blower pumps are designed and manufactured in compliance with EU safety regulations and are assessed against risks according to the standard **UNI EN ISO 12100:2010**, in particular they conform to directive 2006/42/CE and subsequent modifications and additions. The design of this pump complies with the definition of "machine" as contained in the **Machinery Directive 2006/42/EC**. The pump carries the CE mark on its identification plate.

DISCLAIMER NOTICE

The information contained in this technical catalogue is up-to-date and valid at the date of its issue as stated in this page. Battioni Pagani® does not have control over the specific usage intent nor can predict all application conditions under which this product may be used. Therefore, the user shall carefully review the information contained herein and consider it within the specific context of its planned installation and use.

In no event, Battioni Pagani® shall be liable for any loss or damage directly or indirectly arising from any person's use or inability to use this technical catalogue and the product herein described either separately or in combination with other equipment. Other than warranties implied by law, no express or implied warranties are granted including the implied warranty of fitness for a particular purpose.

INFORMAZIONI SULLA CONFORMITÀ DEL PRODOTTO

Le pompe per vuoto / pressione Battioni Pagani® sono progettate e prodotte in conformità con le normative di sicurezza dell'UE e seguendo i principi di valutazione dei rischi previsti dalla norma **UNI EN ISO 12100: 2010**, in particolare sono conformi alla direttiva 2006/42 / CE e successive modifiche e integrazioni. Il design di questa pompa

è conforme alla definizione di "macchina" contenuta nella **Direttiva Macchine 2006/42/CE**.

La pompa riporta il marchio CE sulla targhetta di identificazione.

DISCLAIMER

Le informazioni contenute in questo catalogo tecnico sono aggiornate e valide alla data di emissione indicata in questa pagina. Battioni Pagani® non ha il controllo sugli utilizzi specifici né può prevedere tutte le condizioni in cui questo prodotto può essere utilizzato. Pertanto, l'utente deve esaminare attentamente le informazioni contenute nel presente documento e considerarle nel contesto specifico di installazione e utilizzo previsti.

In nessun caso Battioni Pagani® sarà responsabile per eventuali perdite o danni direttamente o indirettamente derivanti dall'uso o dall'incapacità di utilizzo di questo catalogo tecnico e del prodotto qui descritto, separatamente o in combinazione con altro equipaggiamento. Oltre alle garanzie implicite per legge, non vengono concesse garanzie esplicite o implicite, inclusa la garanzia implicita di idoneità per uno scopo particolare.

CONTACT | CONTATTI

For the latest specification, additional product information, worldwide sales and distributions locations please contact: /

For the latest specification, additional product information, worldwide sales and distributions locations please contact:

➤ info@bapag.it

For technical questions and application information: / Per informazioni tecniche su prodotti e applicazioni:

➤ service@bapag.it

www.bapag.it