

Adjust of the circuit breaker  
Einstellung des Schalters

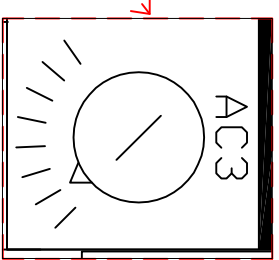

Adjust the circuit breaker according to the power of the pump  
Den Schalter gemäß der Kraft der Pumpe eichen

Adjust of the hour  
Stunde Einstellung

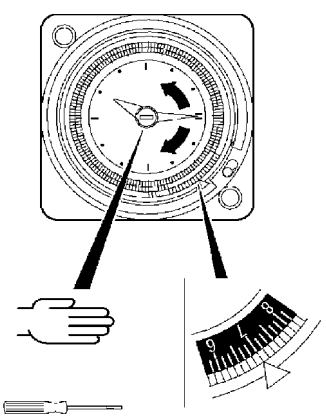

Adjust of the working time  
Zeit des Funktionierens Einstellung

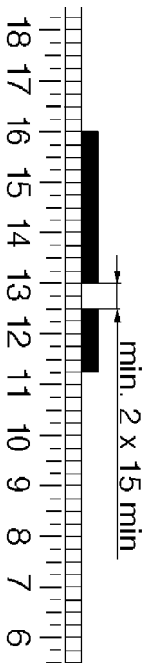
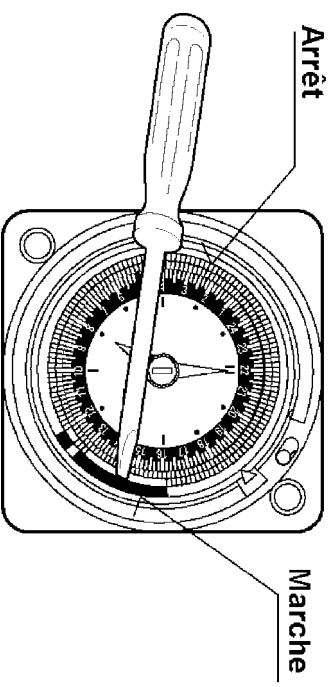

Heat pump NOT controlled by filtration  
Durch das Filteren NICHT kontrollierte Wärmepumpe

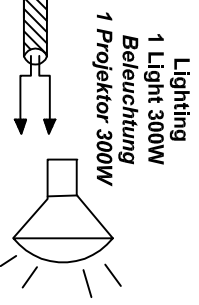
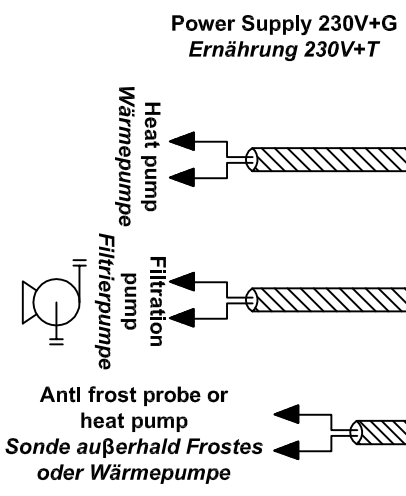

All the cables must be U1000R2V type  
Alle Kradel müssen vom Typ U1000R2V

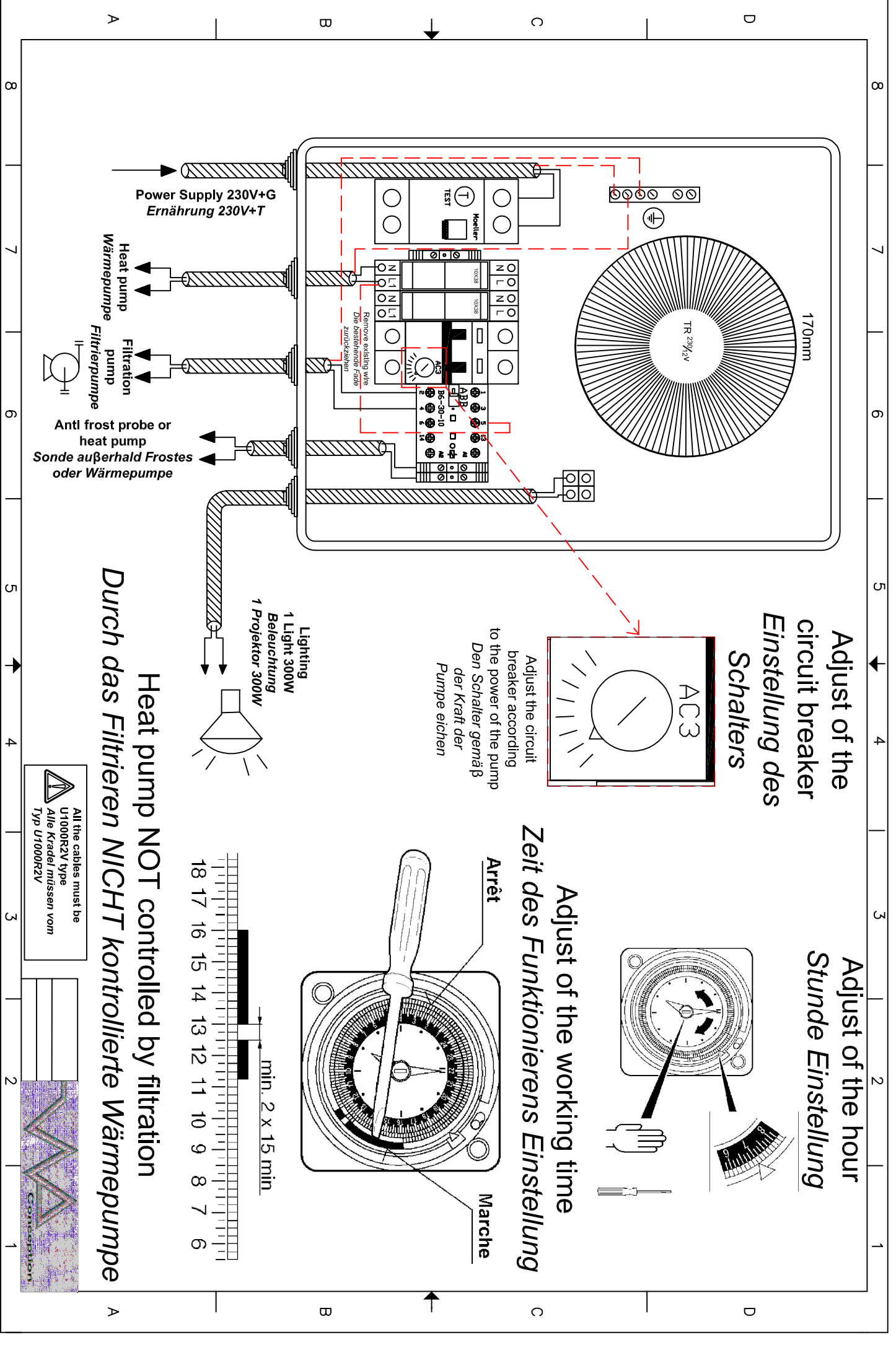
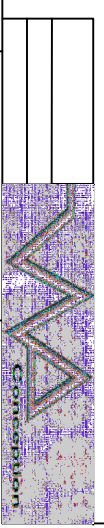

Adjust of the circuit breaker  
 Einstellung des Schalters

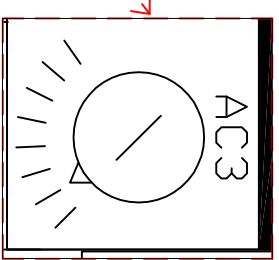

Adjust the circuit breaker according to the power of the pump  
 Den Schalter gemäß der Kraft der Pumpe eichen

Adjust of the hour  
 Stunde Einstellung

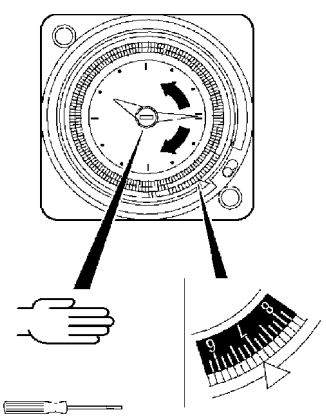

Adjust of the working time  
 Zeit des Funktionierens Einstellung

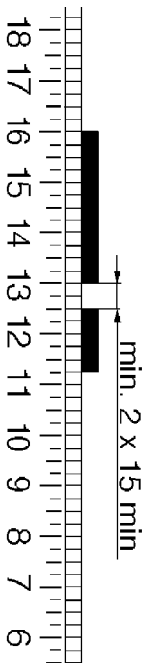
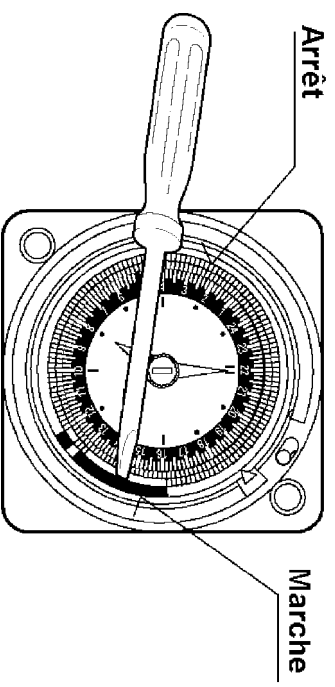

Heat pump controlled by filtration  
 Durch das Filterieren kontrollierte Wärmepumpe

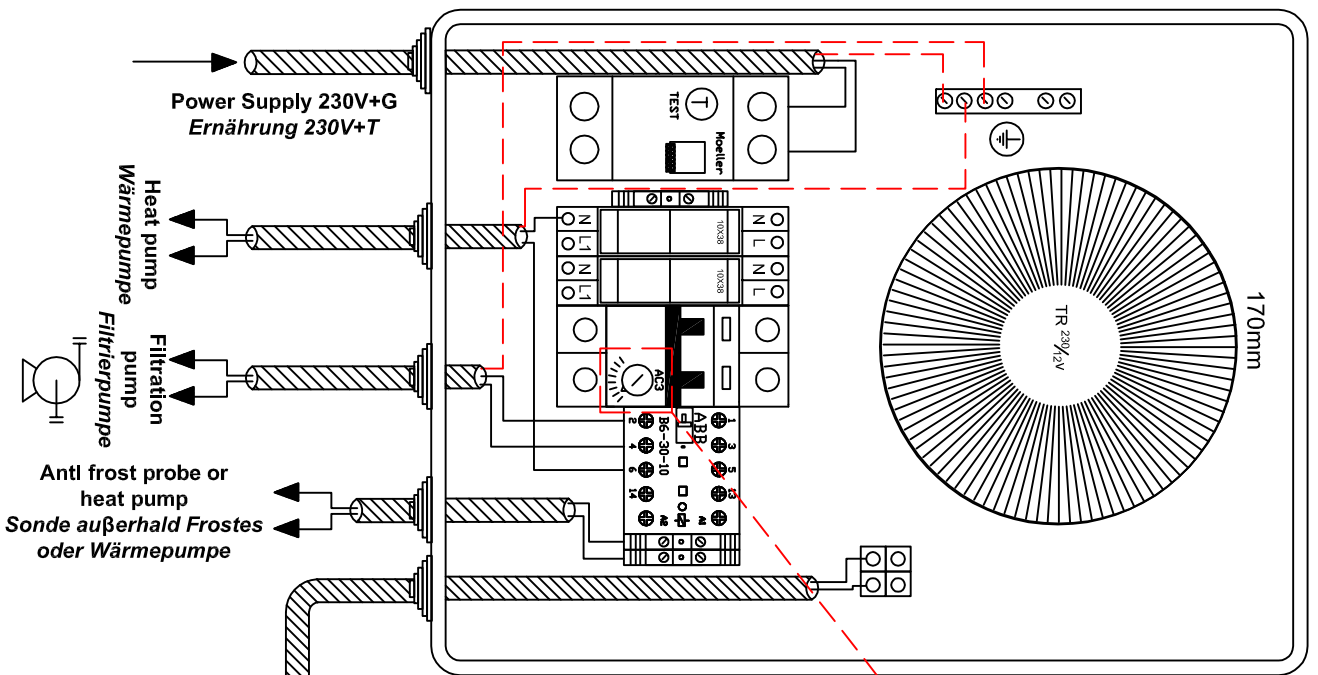

Power Supply 230V+G  
 Ernährung 230V+T

Heat pump  
 Wärmepumpe

Filtration pump  
 Filterpumpe

Anti frost probe or heat pump  
 Sonde außerhalb Frostes oder Wärmepumpe

Lighting  
 1 Light 300W  
 Beleuchtung  
 1 Projektor 300W

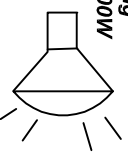

All the cables must be U1000R2V type  
 Alle Kradel müssen vom Typ U1000R2V

