

Catalogo generale ricambi

General spare parts catalogue

Catalogue générale des pièces de rechange

Ersatzteile-katalog

Catálogo de piezas

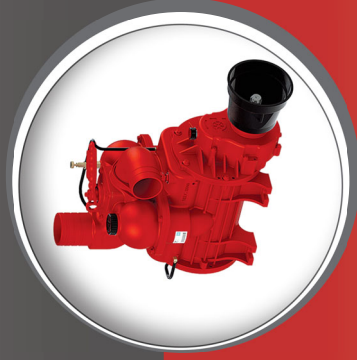
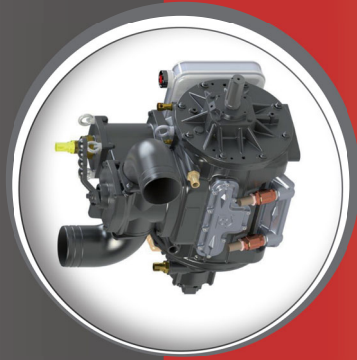

**Battioni®
Pagani**

Setting the pace since 1953

2021



Battioni®
Pagani

MEC 5000-6500-8000 / M

Rev. 0 - 01/05/2021

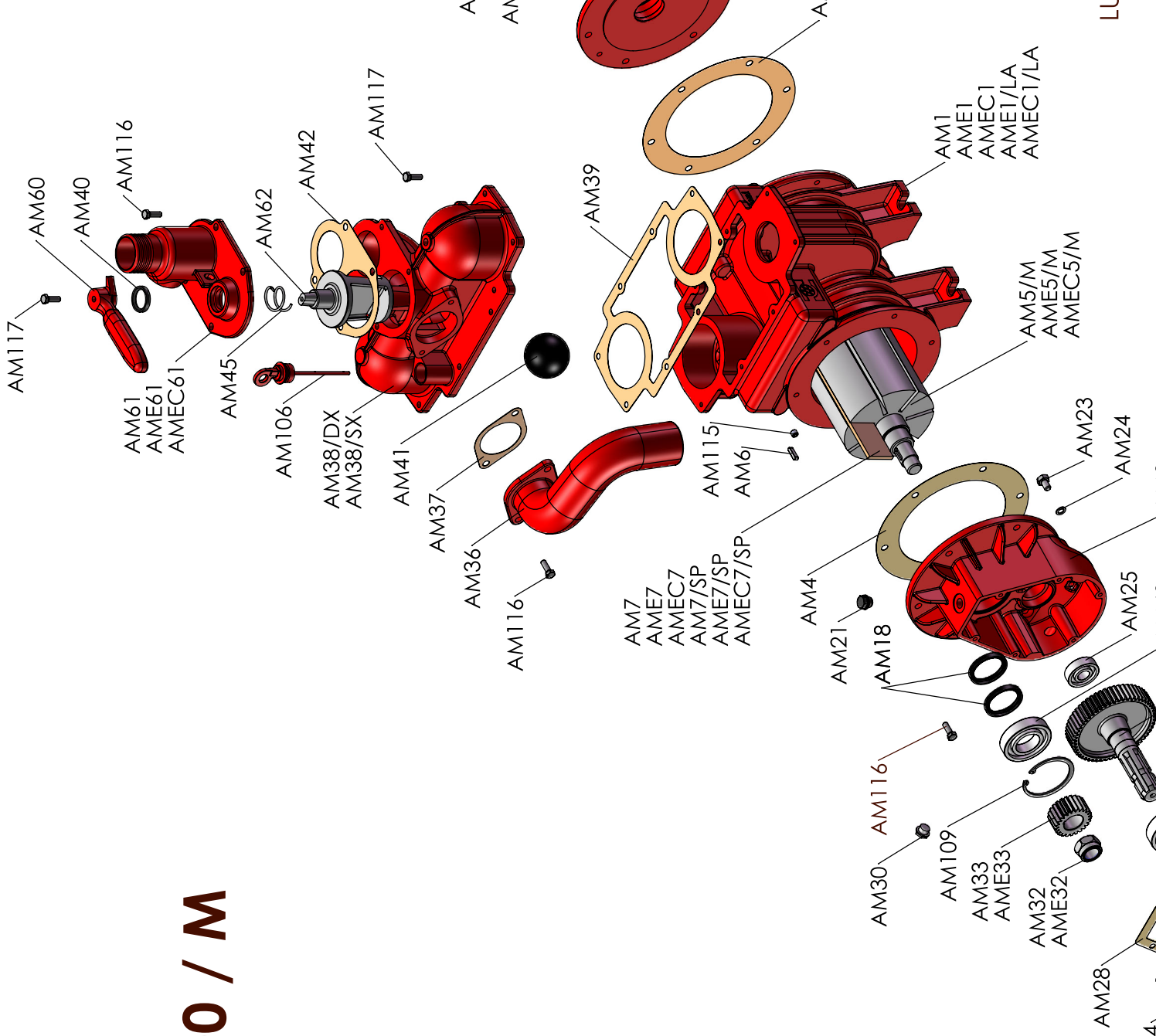



Battioni®
Pagani

MEC 5000-6500-8000 / P

Rev. 0 - 01/05/2021

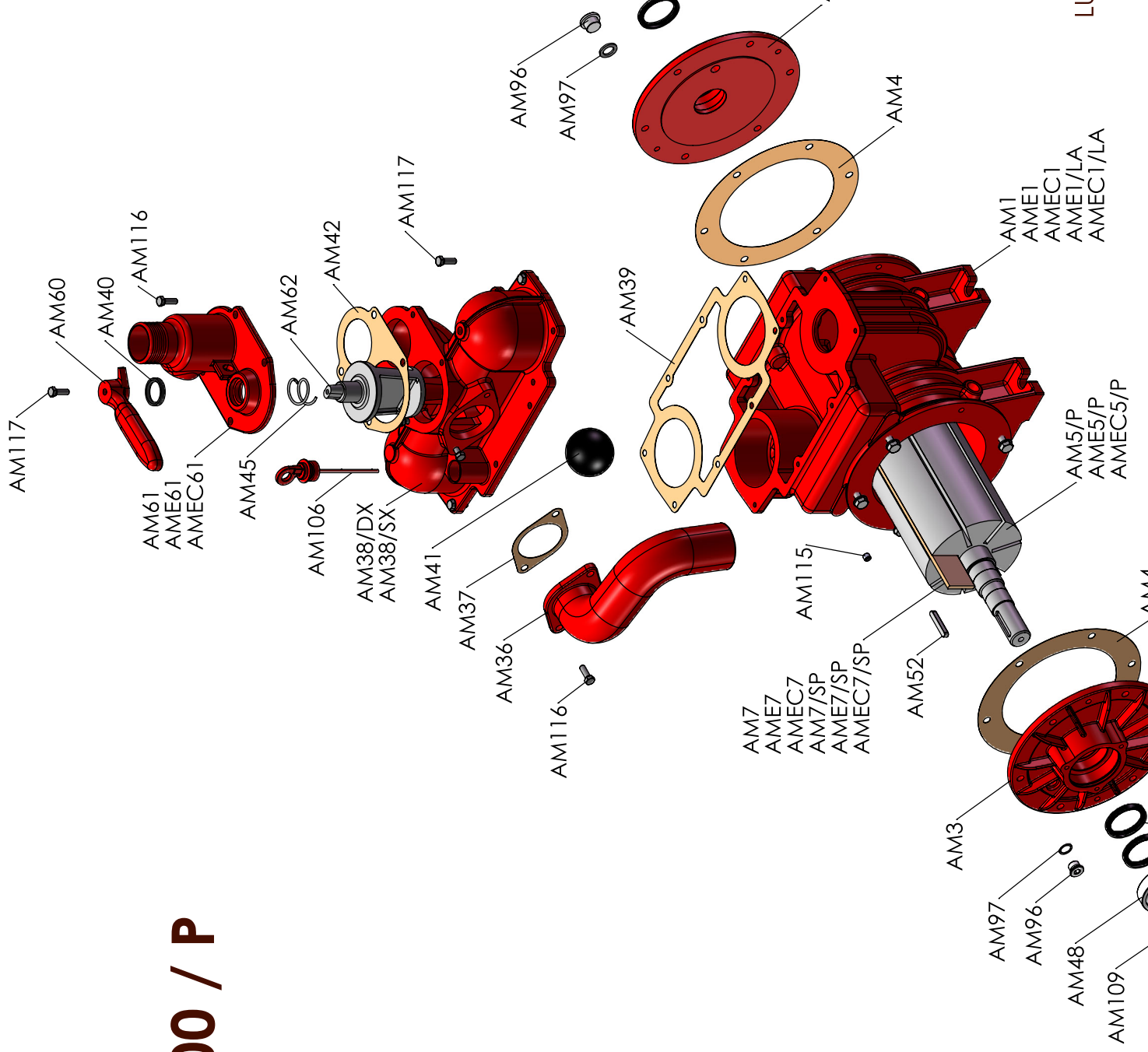



Battioni®
Pagani

MEC 5000-6500-8000 / D

Rev. 0 - 01/05/2021

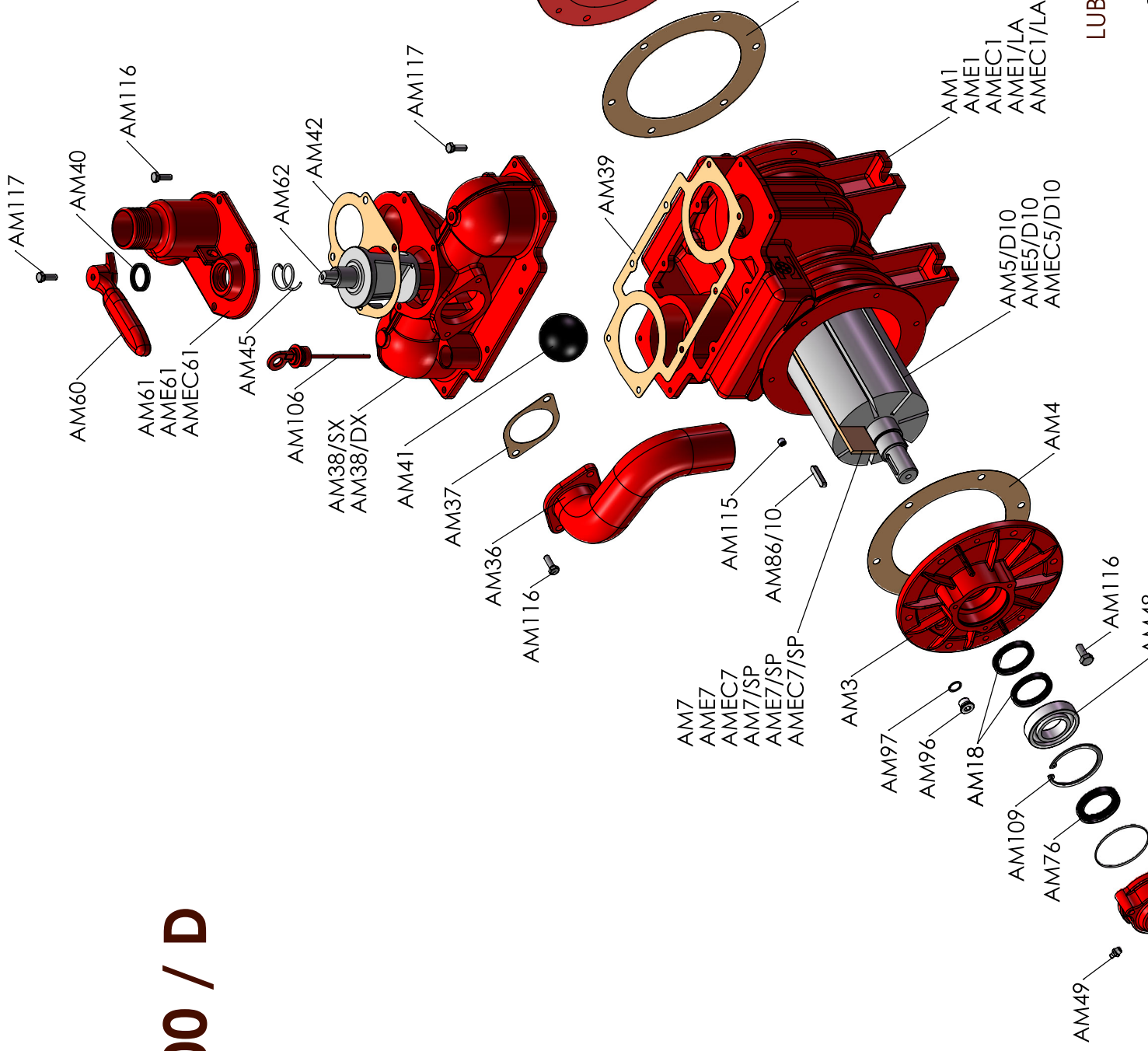



Battioni®
Pagani

MEC 5000-6500-8000 / H

Rev. 0 - 01/05/2021

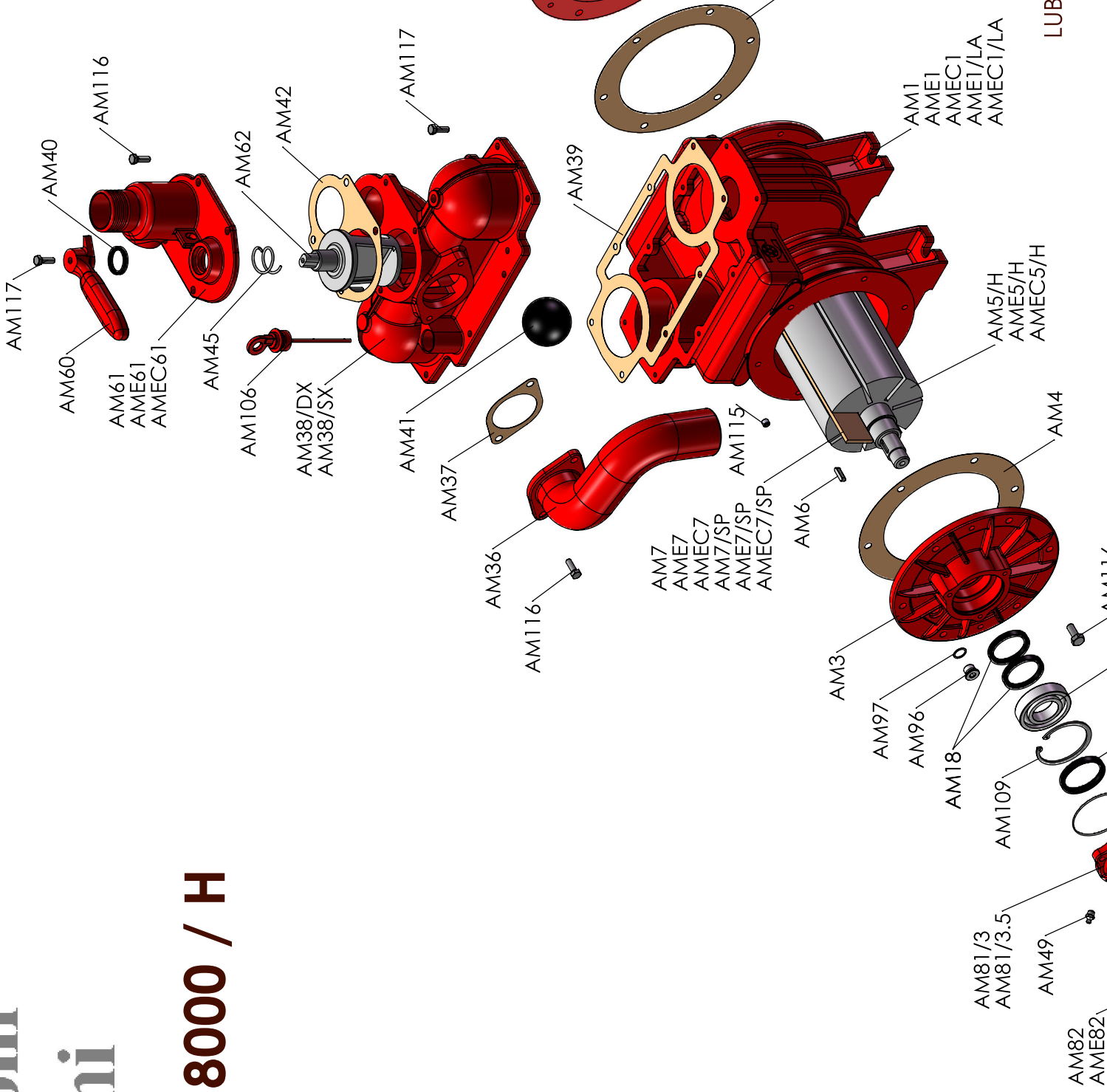

LUB



Battioni®
Pagani

MEC 5000-6500-8000 / HM

Rev. 0 - 01/05/2021

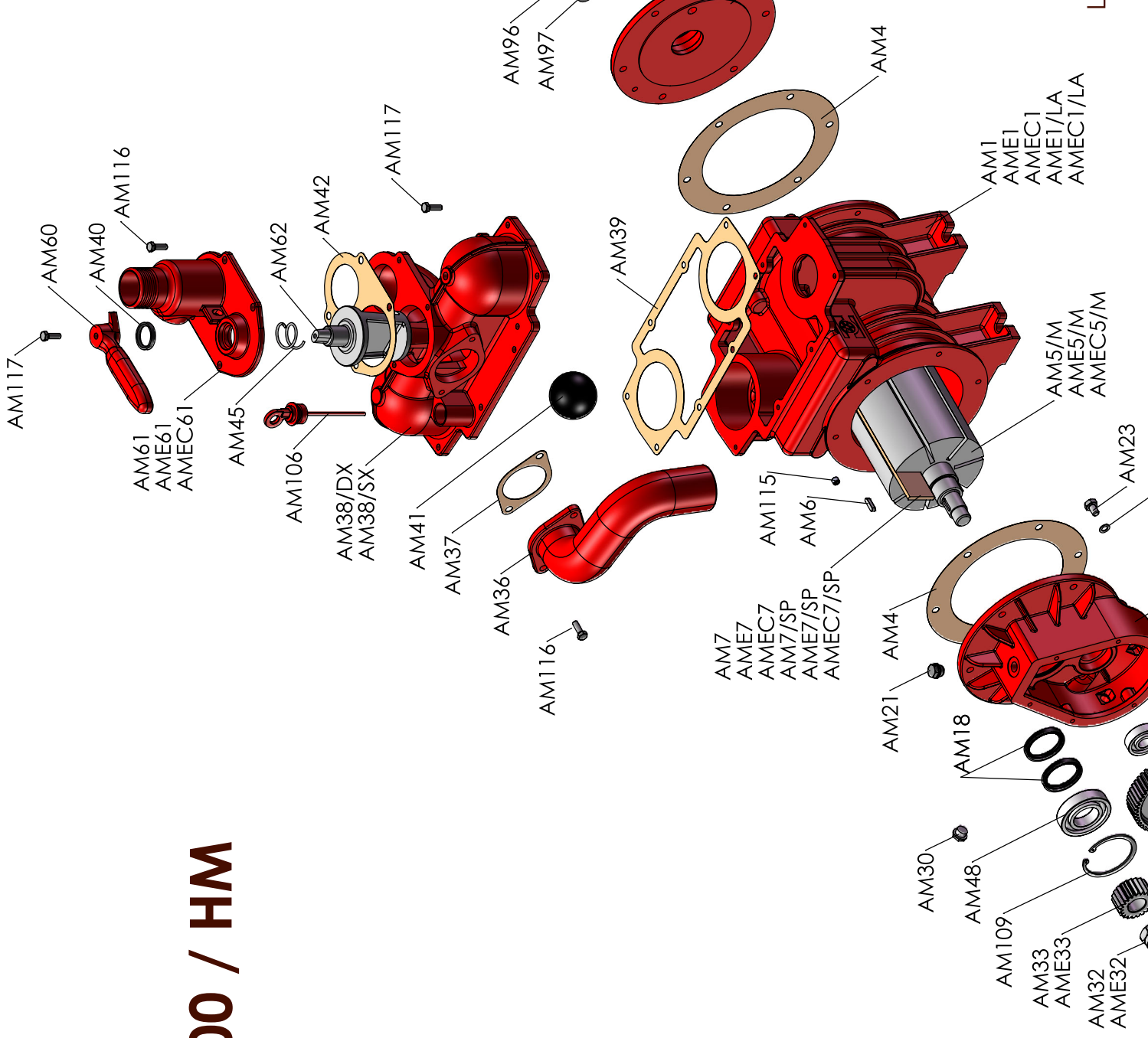



Battioni®
Pagani

MEC 5000-6500-8000 / G-GA

Rev. 0 - 01/05/2021

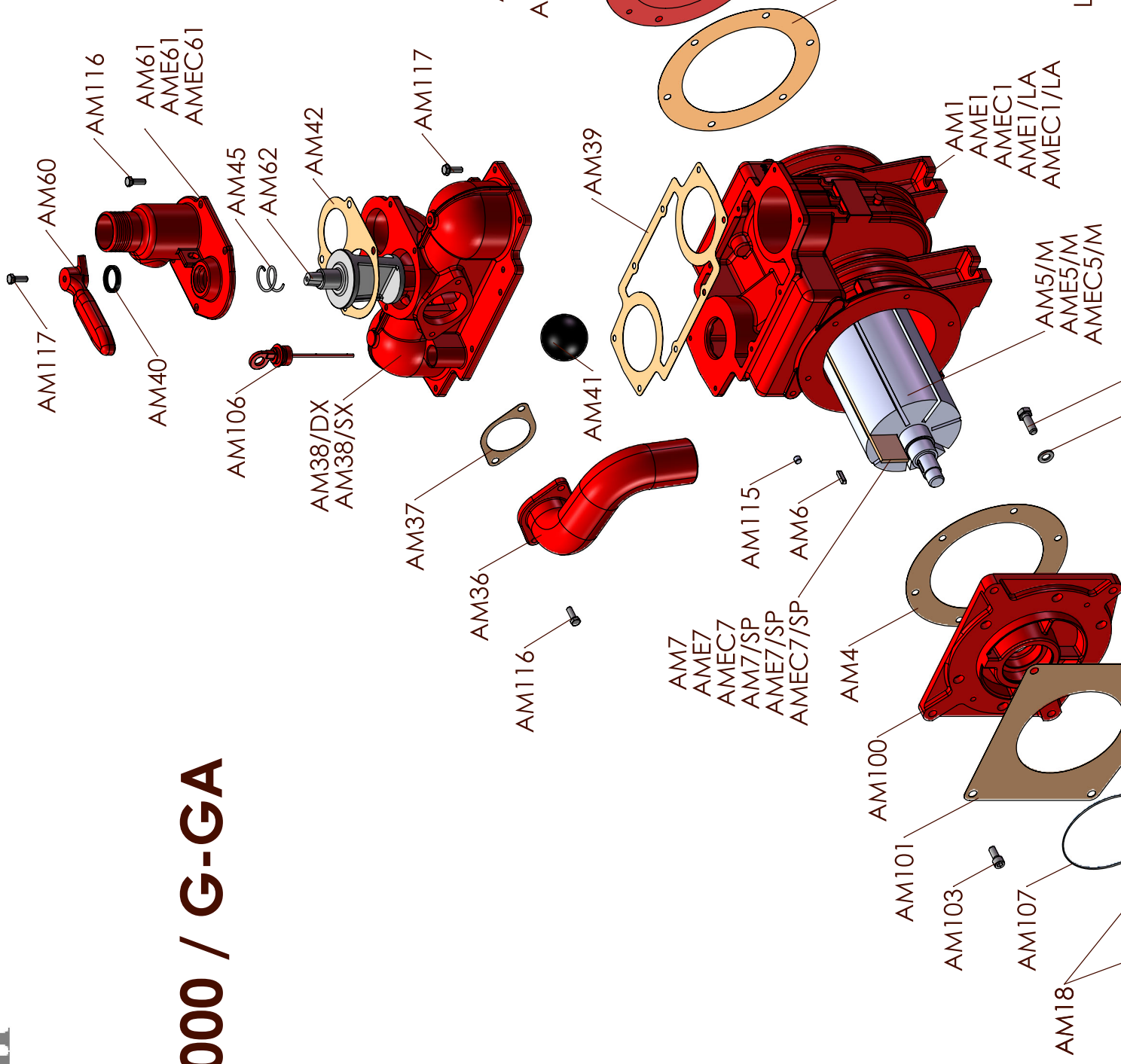



Battioni®
Pagani

MEC 5000-6500-8000 / U.L.

Rev. 0 - 01/05/2021

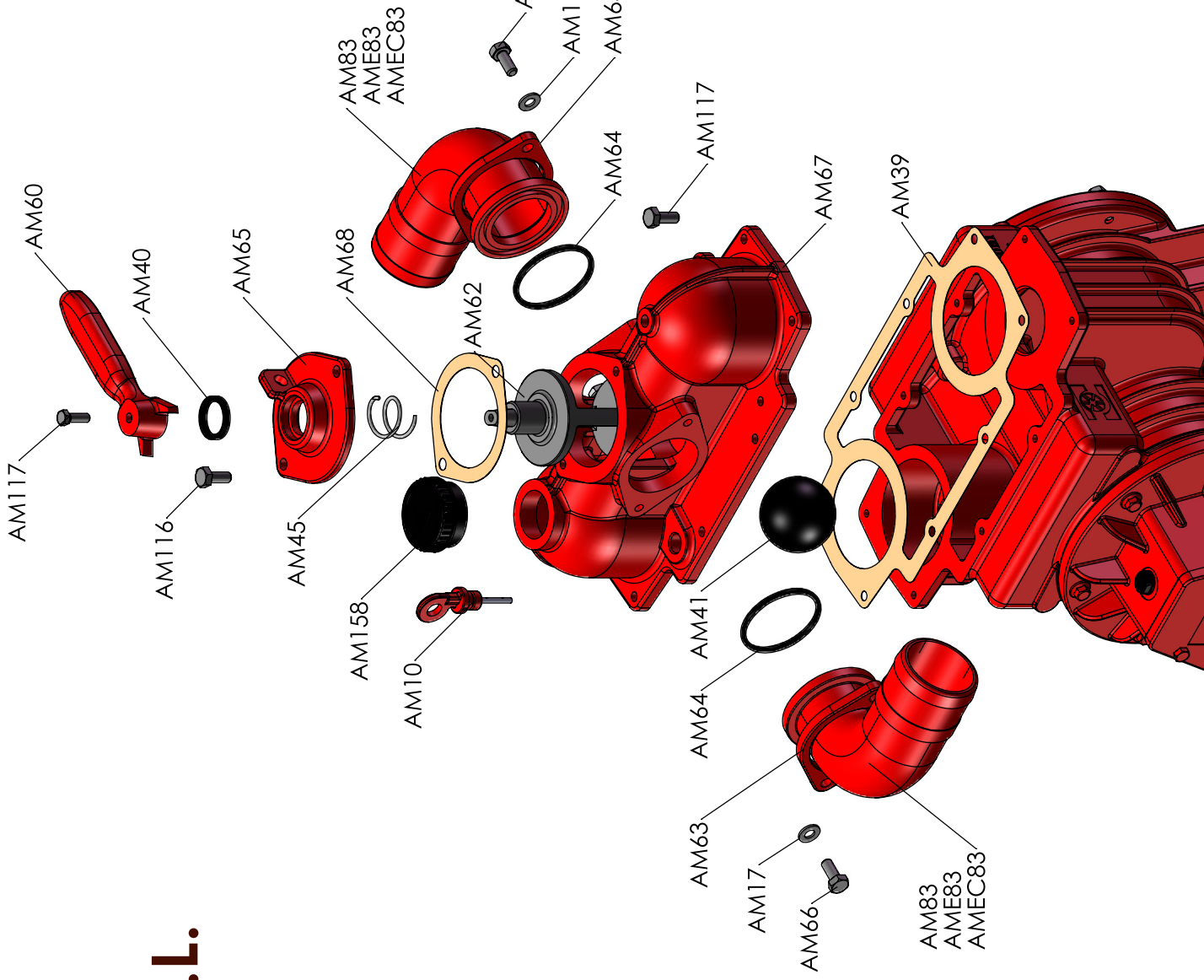



Battioni®
Pagani

MEC 5000-6500-8000 / D.U.

Rev. 0 - 01/05/2021

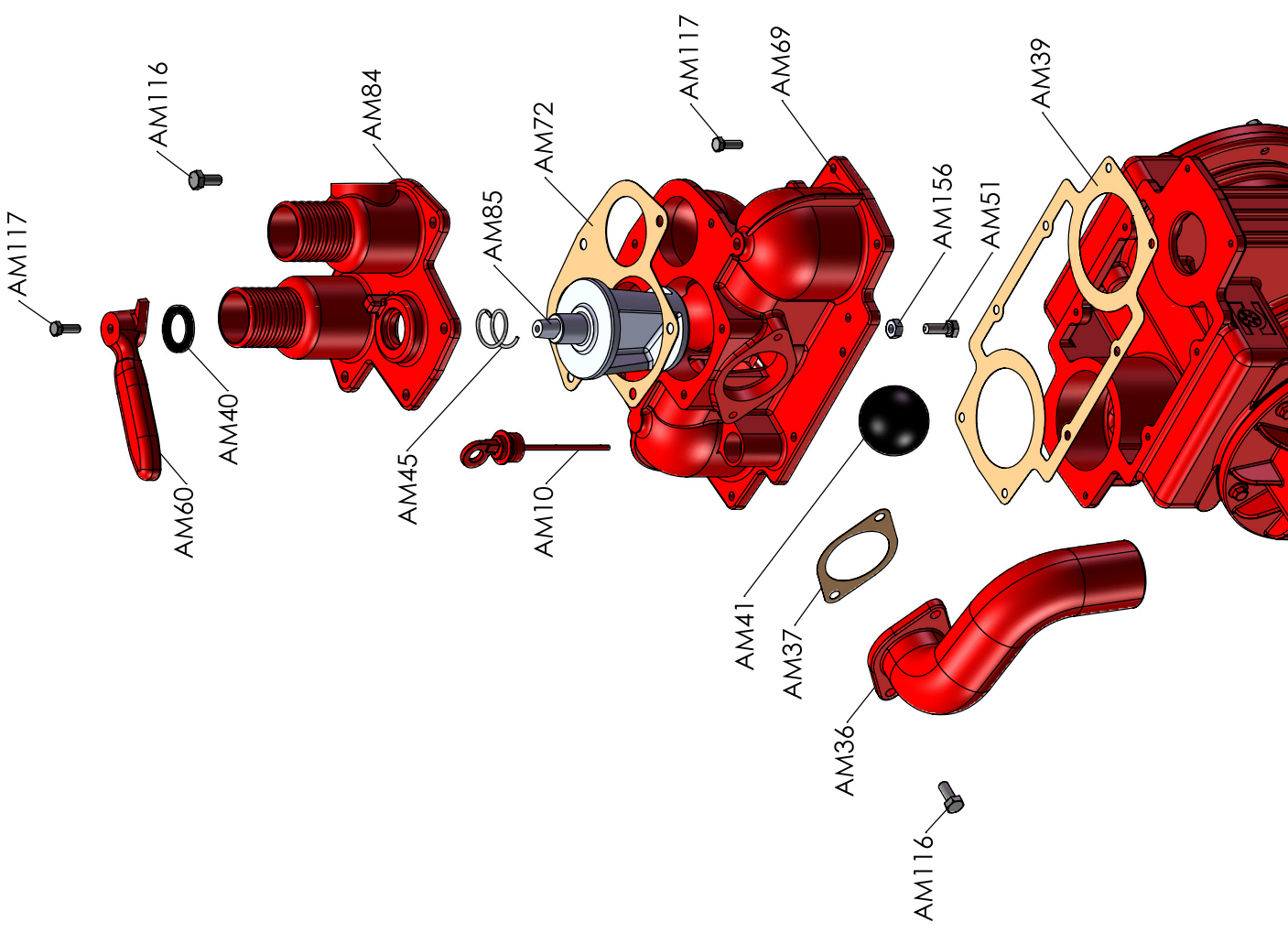



Battioni®
Pagani

MEC 5000-6500-8000 / S.C.

Rev. 0 - 01/05/2021

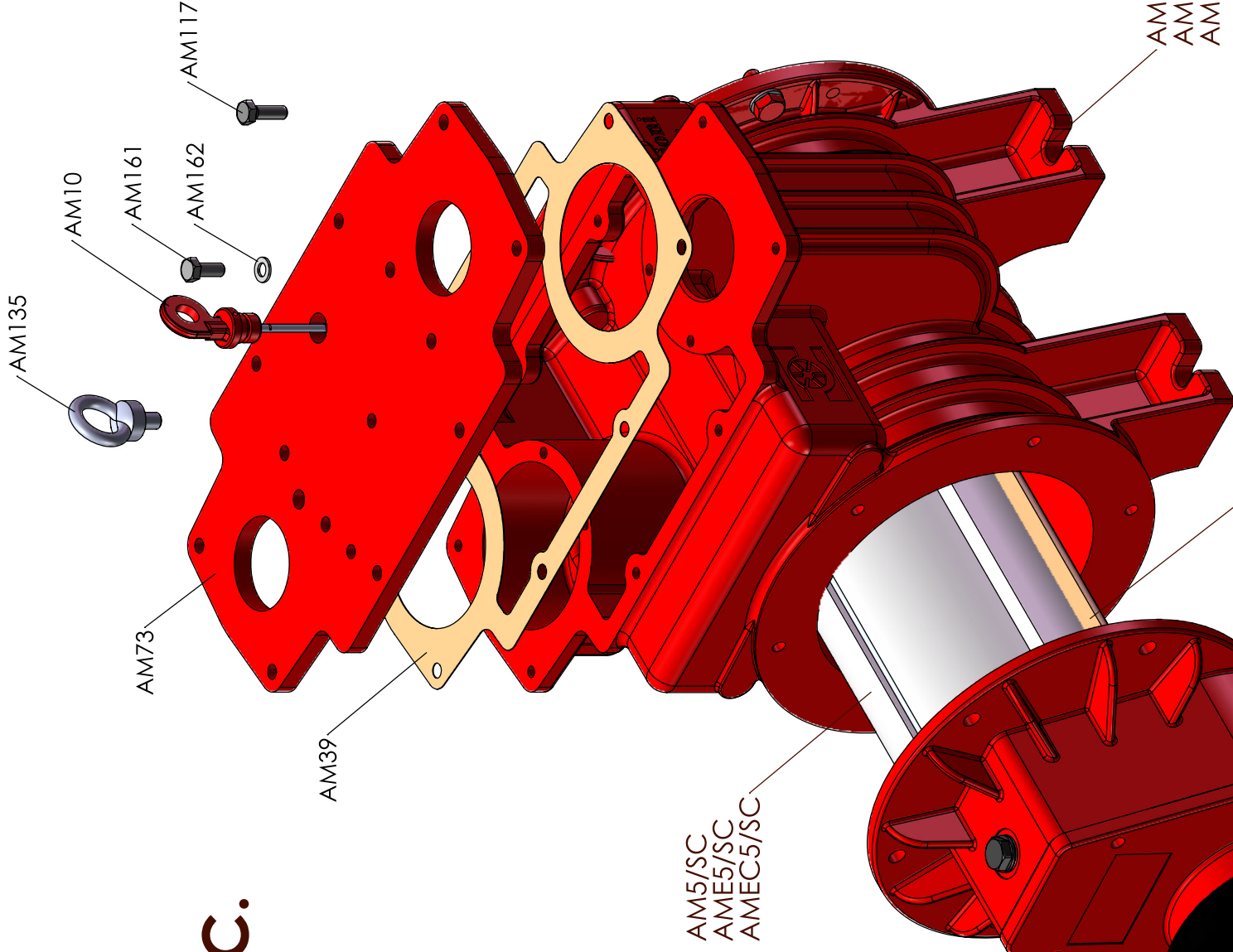

CODE	ARTICLE	DESCRIZIONE	DESCRIPTION	Q.TY	UM
AM1	4010101006	CORPO POMPA MEC 5000	HOUSING - MEC 5000	1	n
AM1/SC	4010101214	CORPO POMPA MEC 5000 SC LF	HOUSING - MEC 5000 SC LF	1	n
AMEC1	4010101007	CORPO POMPA MEC 6500 LF	HOUSING - MEC 6500 LF	1	n
AMEC1/LA	4010101097	CORPO POMPA MEC 6500 LA	HOUSING - MEC 6500 LA	1	n
AMEC1/SC	4010101098	CORPO POMPA MEC 6500 SC LF	HOUSING - MEC 6500 SC LF	1	n
AME1	4010101008	CORPO POMPA MEC 8000 LF	HOUSING - MEC 8000 LF	1	n
AME1/LA	4010101099	CORPO POMPA MEC 8000 LA	HOUSING - MEC 8000 LA	1	n
AME1/SC	4010101100	CORPO POMPA MEC 8000 SC LF	HOUSING - MEC 8000 SC LF	1	n
AM2	4010301003	SCATOLA MOLT. MEC 5-6,5-8000/M	GEARBOX - MEC 5-6,5-8000/M	1	n
AM3	4010401003	FLANGIA ANT. POST. MEC 5-6,5-8000	FRONT AND BACK FLANGE - MEC 5-6,5-8000	1	n
AM4	4030108007	GUARN. FLANGIA MEC 5-8000	FLANGE GASKET - MEC 5-8000	2	n
AM5/M	4010220014	ROTORE MEC 5000/M	ROTOR - MEC 5000/M	1	n
AMEC5/M	4010220015	ROTORE MEC 6500/M	ROTOR - MEC 6500/M	1	n
AME5/M	4010220016	ROTORE MEC 8000/M	ROTOR - MEC 8000/M	1	n
AM5/P	4010220017	ROTORE MEC 5000/P	ROTOR - MEC 5000/P	1	n
AMEC5/P	4010220018	ROTORE MEC 6500/P	ROTOR - MEC 6500/P	1	n
AME5/P	4010220019	ROTORE MEC 8000/P	ROTOR - MEC 8000/P	1	n
AM5/D10	4010220218	ROTORE MEC 5000/D CH.10	ROTOR - MEC 5000/D CH.10	1	n
AMEC5/D10	4010220219	ROTORE MEC 6500/D CH.10	ROTOR - MEC 6500/D CH.10	1	n
AME5/D10	4010220220	ROTORE MEC 8000/D CH.10	ROTOR - MEC 8000/D CH.10	1	n
AM5/H	4010220081	ROTORE MEC 5000/H	ROTOR - MEC 5000/H	1	n
AMEC5/H	4010220082	ROTORE MEC 6500/H	ROTOR - MEC 6500/H	1	n
AME5/H	4010220083	ROTORE MEC 8000/H	ROTOR - MEC 8000/H	1	n
AMEC5/SC	4010220142	ROTORE MEC 6500/M SC	ROTOR - MEC 6500/M SC	1	n
AME5/SC	4010220143	ROTORE MEC 8000/M SC	ROTOR - MEC 8000/M SC	1	n
AM5/SC	4010220141	ROTORE MEC 5000/M SC	ROTOR - MEC 5000/M SC	1	n
AM6	5050707002	CHIAVETTA 6X6X25	KEY - 6X6X25	1	n
AM7	4070113006	PALETTA STANDARD MEC 5000 300X46.5X6.5	STANDARD BLADE - MEC 5000 300X46.5X6.5	7	n
AMEC7	4070113007	PALETTA STANDARD MEC 6500 370X46.5X6.5	STANDARD BLADE - MEC 6500 370X46.5X6.5	7	n
AME7	4070113008	PALETTA STANDARD MEC 8000 450X46.5X6.5	STANDARD BLADE - MEC 8000 450X46.5X6.5	7	n
AM7/SP	4070113123	PALETTA LONG LIFE MEC 5000 300X46.5X6.5	LONG LIFE BLADE - MEC 5000 300X46.5X6.5	7	n
AMEC7/SP	4070113124	PALETTA LONG LIFE MEC 6500 370X46.5X6.5	LONG LIFE BLADE - MEC 6500 370X46.5X6.5	7	n
AME7/SP	4070113125	PALETTA LONG LIFE MEC 8000 450X46.5X6.5	LONG LIFE BLADE - MEC 8000 450X46.5X6.5	7	n
AMEC7/SC	4070113180	PALETTA STANDARD S.C. MEC 6500 369X46.5X9.7	STANDARD BLADE S.C. - MEC 6500 369X46.5X9.7	5	n
AME7/SC	4070113181	PALETTA STANDARD S.C. MEC 8000 448X46.5X9.7	STANDARD BLADE S.C. - MEC 8000 448X46.5X9.7	5	n
AM7/SC	4070113182	PALETTA STANDARD S.C. MEC 5000 299X46.5X9.7	STANDARD BLADE S.C. - MEC 5000 299X46.5X9.7	5	n
AM10	5060100002	ASTA LIVELLO OLIO 18X79 MM	OIL LEVEL ROD - 18X79 MM	1	n
AM12	5012107010	CUSCINETTO A SFERE 6307	BALL BEARING - 6307	1	n
AM17	5050207004	RONDELLA D 10	SMOOTH WASHER - D 10	4	n
AM18	5030300006	PARAOLIO 48X62X8	OIL SEAL - 48X62X8	4	n
AM20	5050207002	RONDELLA D 6	SMOOTH WASHER - D 6	3	n
AM21	5060605001	TAPPO CARICO OLIO D 3/8" GAS	OIL PLUG - D 3/8" GAS	1	n
AM23	5050107018	VITE M 10X16 TE	SCREW - M 10X16 TE	1	n
AM24	5050207034	RONDELLA DI SICUREZZA D 10	SECURITY WASHER D 10	1	n
AM25	5012107006	CUSCINETTO A SFERE 6304	BALL BEARING - 6304	1	n
AM26	4020507002	INGR. CON ALBERO MEC 2-5000 Z55-M2,5	GEAR WITH SHAFT - Z55-M2,5 MEC 2-5000	1	n
AME26	4020507003	INGR. CON ALBERO MEC 6,5-8000 Z53-M2,5	GEAR WITH SHAFT - Z53-M2,5 MEC 6,5-8000	1	n
AM27	5030300005	PARAOLIO 35X62X10	OIL SEAL - 35X62X10	1	n
AM28	4030108006	GUARN. COPERCHIO SCAT. MOLT. MEC 2-8000	GEARBOX COVER GASKET - MEC 2-8000	1	n
AM30	5060105004	TAPPO LIVELLO OLIO D 3/8" GAS	OIL LEVEL PLUG - D 3/8" GAS	1	n
AM32	5050300001	DADO AUTOBLOCCANTE M 24X2X15	SELF-LOCKING NUT - M 24X2X15	1	n
AME32	5050300002	DADO AUTOBLOCCANTE M 27X2X16	SELF-LOCKING NUT - M 27X2X16	1	n
AM33	4020607002	PIGNONE MEC 2-5000 Z21-M2,5	PINION - Z21-M2,5 MEC 2-5000	1	n
AME33	4020607003	PIGNONE MEC 6,5-8000 Z23-M2,5	PINION - Z23-M2,5 MEC 6,5-8000	1	n
AM36	4010901003	CURVA DI SCARICO MEC 5-8000	EXHAUST ELBOW - MEC 5-8000	1	n
AM37	4030110003	GUARN. LATERALE COLL. MEC 5-8000	MANIFOLD SIDE GASKET - MEC 5-8000	1	n
AM38/DX	4010501004	COLLETTORE MEC 5-8000 DX	MANIFOLD - MEC 5-8000 DX	1	n
AM38/SX	4010501025	COLLETTORE MEC 5-8000 SX	MANIFOLD - MEC 5-8000 SX	1	n

CODE	ARTICLE	DESCRIZIONE	DESCRIPTION	Q.TY	UM
AM39	4030109005	GUARN. COLLETTORE MEC 5-8000	MANIFOLD GASKET - MEC 5-8000	1	n
AM40	5030300007	PARAOLIO 30X40X7 TC	OIL SEAL - 30X40X7 TC	1	n
AM41	5060410006	SFERA IN GOMMA PESANTE D 70	RUBBER BALL - D 70	1	n
AM42	4030109006	GUARN. COPERCHIO COLL. MEC 5-8000	MANIFOLD COVER GASKET - MEC 5-8000	1	n
AM45	4012007002	MOLLA MEC 5-8000	SPRING - MEC 5-8000	1	n
AM48	5012107004	CUSCINETTO A SFERE 6208	BALL BEARING - 6208	2	n
AM49	5050812001	INGRASSATORE M 10X1	LUBRICATOR - M 10X1	1	n
AM50	5050207008	RONDELLA TRANCIATA D 10X40	BLANK WASHER - D 10X40	1	n
AM51	5050107021	VITE M 10X30 TE	SCREW - M 10X30 TE	4	n
AM52	5050707007	CHIAVETTA 8X7X50	KEY - 8X7X50	1	n
AM53	5030300002	PARAOLIO 35X52X10	OIL SEAL - 35X52X10	1	n
AM60	4010801007	MANIGLIA MEC 2-8000	HANDLE - MEC 2-8000	1	n
AM61	4010601075	COPERCHIO COLLETTORE D 60 MEC 5-6500	MANIFOLD COVER - D 60 MEC 5-6500	1	n
AME61	4010601076	COPERCHIO COLLETTORE D 80 MEC 8000	MANIFOLD COVER - D 80 MEC 8000	1	n
AMEC61	4010601016	COPERCHIO COLLETTORE D 76 MEC 5-6,5-8000	MANIFOLD COVER - D 76 MEC 5-6,5-8000	1	n
AM62	4010701012	CONO INVERTITORE MEC 5-8000	REVERSING GEAR - MEC 5-8000	1	n
AM63	4010406004	FLANGIA PREMICURVA - MEC 5/6,5/8000	SUPPORT FLANGE - MEC 5/6,5/8000	2	n
AM64	5030210019	ANELLO TENUTA OR 179 MEC 5000 UL	SEAL RING - OR 179	2	n
AM65	4010601078	COPERCHIO COLLETTORE MEC 5-6,5-8000 UL	MANIFOLD COVER - MEC 5-6,5-8000 UL	1	n
AM66	5050107022	VITE M 10X40 TE	SCREW - M 10X40 TE	4	n
AM67	4010501012	COLLETTORE MEC 5-8000 UL	MANIFOLD - MEC 5-8000 UL	1	n
AM68	4030109027	GUARN. COPERCHIO COLL. MEC 5-8000 UL	MANIFOLD COVER GASKET - MEC 5-8000 UL	1	n
AM69	4010501005	COLLETTORE MEC 5-8000 DU	MANIFOLD - MEC 5-8000 DU	1	n
AM72	4030109009	GUARN. COPERCHIO COLL. MEC 5-8000 DU	MANIFOLD COVER GASKET - MEC 5-8000 DU	2	n
AM73	4010606004	COPERCHIO SERBATOIO OLIO MEC 5-8000 SC	OIL TANK COVER - MEC 5-8000 SC	1	n
AM75	5050107125	VITE M 10X110 TCEI	SCREW - M 10X110 TCEI	1	n
AM76	5030300032	PARAOLIO 45X60X10	OIL SEAL - 45X60X10	1	n
AM80	5030300013	PARAOLIO 55X68X8	OIL SEAL - 55X68X8	1	n
AM81/3	4011001045	SUPPORTO MOTORE IDR. MEC 2-8000/H GR. 3	HYDR. MOT. SUPPORT - MEC 2-8000/H GR. 3	1	n
AM81/3,5	4011001016	SUPPORTO MOTORE IDR.MEC 2-11000/H GR.3,5	HYDR. MOT. SUPPORT - MEC 2-11000/H GR.3,5	1	n
AM82	4020107006	MANICOTTO TRASM. MOT. IDR. MEC 2-5000	HYDR. MOTOR TRANSM. COUPLING MEC 2-5000	1	n
AME82	4020107007	MANICOTTO TRASM. MOT. IDR. MEC 6,5-8000	HYDR. MOTOR TRANSM.COUPLING MEC6,5-8000	1	n
AM83	4010901013	CURVA DI SCARICO ORIENT. MEC 5-8000 D 76	REVOLVING ELBOW - MEC 5-8000 D 76	2	n
AME83	4010906004	CURVA DI SCARICO ORIENT. MEC 5-8000 D 80	REVOLVING ELBOW - MEC 5-8000 D 80	2	n
AMEC83	4010901024	CURVA DI SCARICO ORIENT. MEC 5-8000 D 60	REVOLVING ELBOW - MEC 5-8000 D 60	2	n
AM84	4010601090	COPERCHIO COLLETTORE MEC 5-8000 DU	MANIFOLD COVER - MEC 5-8000 DU	1	n
AM85	4010701013	CONO INVERTITORE MEC 5-8000 DU	REVERSING GEAR - MEC 5-8000 DU	1	n
AM86/10	5050707031	CHIAVETTA 10X8X40	KEY 10X8X40	1	n
AME87/D	5020107028	PRESA CALETTATA FORO D 32 - Ø 1"3/8 - CH.10	SPLINED HUB HOLE D 32 - Ø 1"3/8 - CH.10	1	n
AM94	4010601115	COPERCHIO SCATOLA MOLT. MEC 2-8000 CE	GEARBOX COVER - MEC 2-8000 CE	1	n
AM95	4060505000	PROTEZIONE ALBERO CE	SHAFT GUARD - CE	1	n
AM96	5050906006	TAPPO M 16x1.5 - DIN 908 -	PLUG - M 16X1.5 - DIN 908	2	n
AM97	5050202007	RONDELLA D 16X20X1,5 ALLUMINIO	ALUMINIUM WASHER - D 16X20X1,5	2	n
AM98	5050107028	VITE M 12X35 TE	SCREW - M 12X35 TE	4	n
AM99	5050207005	RONDELLA D 12	SMOOTH WASHER - D 12	4	n
AM100	4010401007	FLANGIA SUPP. DECOM. GARDA/5-8000	PUMP SUPPORT FLANGE - MEC/G 5-8000	1	n
AM101	4030108029	GUARN. FLANGIA SUPP. DECOMPR. MEC /G	PUMP SUPPORT GASKET - MEC/G	1	n
AM102	4020607004	PIGNONE DEC. GARDA MEC 2-5000 Z39-M3	GARDA PINION - Z39-M3 MEC 2-5000	1	n
AME102	4020607005	PIGNONE DEC. GARDA MEC 6,5-8000 Z39-M3	GARDA PINION - Z39-M3 MEC 6,5-8000	1	n
AM103	5050107026	VITE M 10X25 TCEI	SCREW - M 10X25 TCEI	6	n
AM105	4020607016	PIGNONE DEC. GARDA MEC 2-5000 GA Z50-M3	GARDA PINION - Z50-M3 MEC 2-5000 GA	1	n
AME105	4020607017	PIGNONE DEC. GARDA MEC6,5-8000 GA Z50-M3	GARDA PINION - Z50-M3 MEC 6,5-8000 GA	1	n
AM106	5060605009	ASTA LIVELLO OLIO 30X130 MM	OIL LEVEL ROD - 30X130 MM	1	n
AM107	5030210060	ANELLO DI TEN. SUPP. DEC. OR171.12x2.62	SEAL RING - OR171.12x2.62 /G	1	n
AM108	5050107197	VITE M 6x10 TEF - FL/ZIGR 8.8 -ZINCATA	GALVANIZED SCREW - M 6X10 TEF	4	n
AM109	5050507011	ANELLO SEEGER D 80 I	CIRCLIP - D 80 I	2	n
AM115	5050903001	TAPPO M 10x1 - DIN 906	PLUG - M 10X1 - DIN 906	2	n
AM116	5050107109	VITE M 10X25 TEF - FL/ZIGR 8.8 -	SCREW - M 10X25 TEF - FL/ZIGR 8.8	19	n

CODE	ARTICLE	DESCRIZIONE	DESCRIPTION	Q.TY	UM
AM117	5050107108	VITE M 8X25 TEF - FL/ZIGR 8.8 -	SCREW - M 8X25 TEF - FL/ZIGR 8.8	18	n
AM119	4010601153	COPERCHIO ANTERIORE MEC 5-13500 /P-AL	FRONT COVER - MEC 5-13500/P AL	1	n
AM120/D	4010601167	COPERCHIO ANTERIORE CE MEC 5000-13500 / D	FRONT COVER - CE MEC 5000-13500 / D	1	n
AM121	5050107122	VITE M 6X25 TE -10.9 -	SCREW - M 6X25 TE -10.9 -	3	n
AME122	4020507017	INGR. CON ALBERO MEC2-5000/HM Z55-M2,5	GEAR WITH SHAFT MEC2-5000/HM Z55-M2,5	1	n
AM122	4020507013	INGR. CON ALBERO MEC6,5-8000/HM Z53-M2,5	GEAR WITH SHAFT MEC6,5-8000/HM Z53-M2,5	1	n
AM124	4030108046	GUARN. SUPP. MOTORE IDR. GR. 3-3.5 MEC	HYDR. MOT. SUPP. GASKET - GR. 3-3.5 - MEC	1	n
AM125	5030210028	ANELLO TENUTA OR 2337-85.34X1.78 POMPA LF	SEAL RING - OR 2337 85,34x1,78 LF PUMP	1	n
AM126	4010601160	COPERCHIO SCATOLA MOLT. HM MEC 2-8000	GEARBOX COVER - MEC 2-8000 HM	1	n
AM127	4011707041	ANELLO DI RIDUZ. PER MOT. IDR. G.3 MEC	CETERING RING FOR HYDR. MOTOR - MEC GR3	1	n
AM151	6080200056	MOTORE IDR. KM 30.43 SO GR.3.5 COMPL.	HYDRAULIC MOTOR KM 30.43 SO GR. 3.5	1	n
AME151	6080200057	MOTORE IDR. KM 30.51 SO GR.3.5 COMPL.	HYDRAULIC MOTOR KM 30.51 SO GR. 3.5	1	n
AM152	5050107054	VITE M 10X35 TE	SCREW - M 10X35 TE	4	n
AM153	5020400034	MOTORE IDRAULICO ORBITALE 130 CC	ORBITAL HYDRAULIC MOTOR 130 CC	1	n
AM155	5051206001	GOLFARE MASCHIO M 10 - CE	MALE EYEBOLT - M 10 - CE	1	n
AM156	5050307003	DADO M 10	NUT M 10	1	n
AM158	5060605005	TAPPO NERO D 1"1/2 GAS	BLACK CAP - D 1"1/2 GAS	1	n
AM159	4011707127	DISTANZIALE MEC 5000-8000/D CH10 - Ø 54X40,2X5,9	SPACER - MEC 5000-8000/D CH10 - Ø 54X40,2X5,9	1	n
AM160	5050207034	RONDELLA DI SICUREZZA D 10 NORD- LOCK	SECURITY WASHER D 10 NORD-LOCK	1	n
AM161	5050107009	VITE M 8X20 TE	SCREW - M 8X20 TE	2	n
AM162	5050207003	RONDELLA D 8	SMOOTH WASHER - D 8	2	n
AM123	6010201006	KIT REVISIONE POMPA MEC 5000 STANDARD	REBUILD KIT - MEC 5000 STANDARD	1	n
AME123	6010201007	KIT REVISIONE POMPA MEC 6500 STANDARD	REBUILD KIT - MEC 6500 STANDARD	1	n
AMEC123	6010201008	KIT REVISIONE POMPA MEC 8000 STANDARD	REBUILD KIT - MEC 8000 STANDARD	1	n
AM123/SP	6010201019	KIT REVISIONE POMPA MEC 5000 LONG LIFE	REBUILD KIT - MEC 5000 LONG LIFE	1	n
AME123/SP	6010201020	KIT REVISIONE POMPA MEC 6500 LONG LIFE	REBUILD KIT - MEC 6500 LONG LIFE	1	n
AMEC123/SP	6010201021	KIT REVISIONE POMPA MEC 8000 LONG LIFE	REBUILD KIT - MEC 8000 LONG LIFE	1	n
AM123/SC	6010201066	KIT REVISIONE POMPA MEC 5000 M S.C.	REBUILD KIT - MEC 5000 M S.C.	1	n
AME123/SC	6010201067	KIT REVISIONE POMPA MEC 6500 M S.C.	REBUILD KIT - MEC 6500 M S.C.	1	n
AMEC123/SC	6010201068	KIT REVISIONE POMPA MEC 8000 M S.C.	REBUILD KIT - MEC 8000 M S.C.	1	n
LUBR_OIL	5070200100	OLIO BATTIONI PAGANI POMPE (5LT)	BATTIONI PAGANI VACUUM PUMP OIL (5LT)	1	n



Battioni®
Pagani

Setting the pace since 1953

0	01.05.2021	I° EMISSIONE	PROG	R DT	AM
REV.	DATA	MOTIVO	PREPARATO	APPROVATO	AUTORIZZATO



Battioni®
Pagani

Setting the pace since 1953

Via Cav. Enzo Ferrari, 2
43058 Ramoscello di Sorbolo (PR) - Italy

Ph. +39 0521 663203

Fax +39 0521 663206



www.bapag.it
info@bapag.it