

# MEC

9000 | 11000 | 13500 | 16500



Battioni®  
Pagani

*Setting the pace since 1953*

# MEC 9000 | 11000 | 13500

Designed in cooperation with SPRInT, the Team of Engineering and Research of the Department of Industrial Engineering at the University of Parma, the MEC pump represents a technology breakthrough **resulted from a major joint effort in product development and innovative design processes.**

*Progettata insieme a SPRInT, il team di ingegneria e ricerca del dipartimento di ingegneria industriale dell'Università di Parma, la pompa MEC rappresenta una svolta tecnologica, risultato di uno sforzo congiunto nello sviluppo del prodotto e di innovativi processi di progettazione.*

**Selector vacuum-pressure/  
Selettore vuoto-pressione**

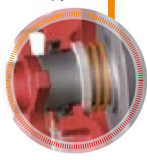

**Predisposition for overpressure valve/  
Predisposizione per valvola di sovrappressione**



**Temperature indicator with 160° C irreversible indicator/  
Rilevatore di temp. con indicatore irreversibile 160° C**

**Forced lubrication pump as standard (automatic lubrication on request)/  
Pompa di lubrificazione forzata di serie (lubrificazione automatica a richiesta)**

**Long Life blades as standard/  
Palette "Long Life" resistenti al calore di serie**



**High wearing resistance thanks to cast-iron with high hardness/  
Elevata resistenza ad usura grazie a ghisa ad alta durezza**

**External Oil level indicator/  
Indicatore livello olio esterno**

**CPS - CRASH PROTECTION SYSTEM**  
Sliding flanges to avoid breakages of the body and rotor during vanes crashes/Flange con asole di scorrimento in caso di ingresso materiale o rottura palette

**Flange-housing alignment controls**  
Tacca di allineamento flangia-corpo

**Blades inspection hole/  
Foro ispezione palette**

**Compression and thrust rings for bearings/  
Anello di compensazione**

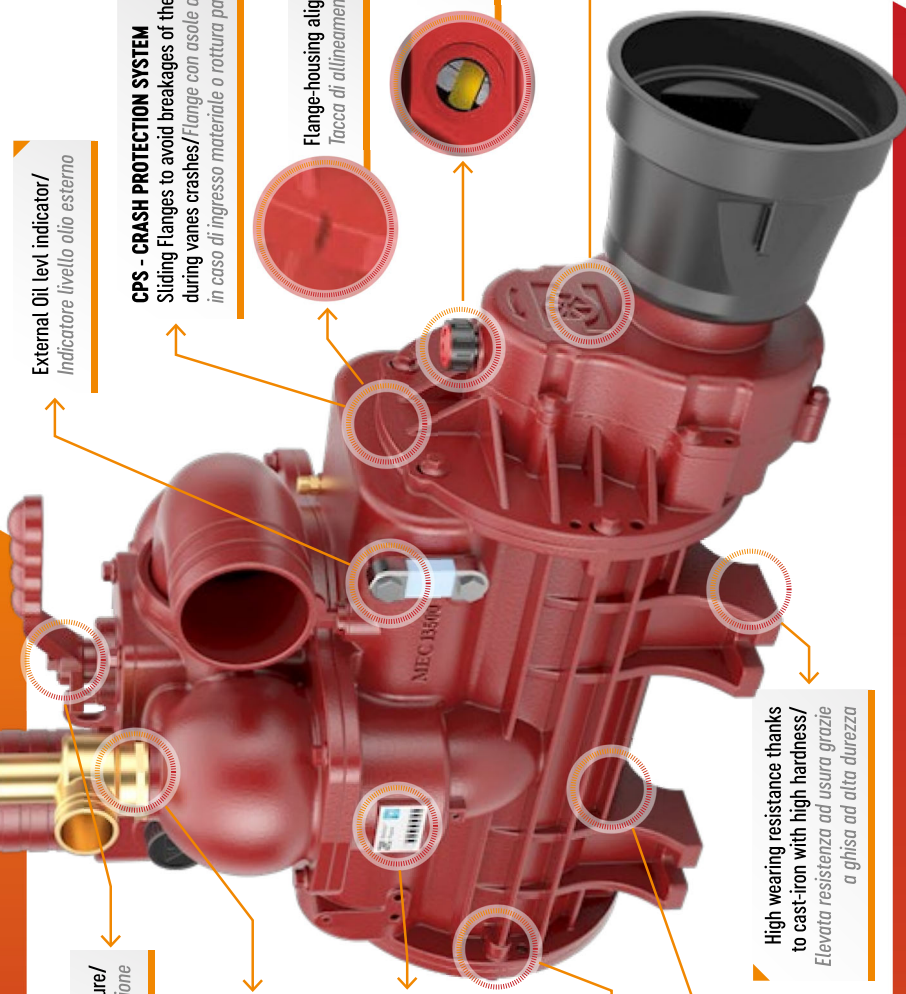
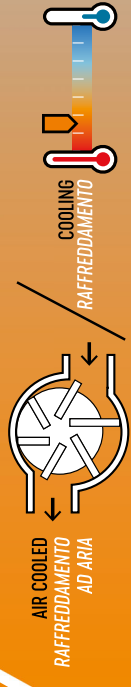

The picture is only for informative purposes. | The picture is only for informative purposes.

# VERSIONS | VERSIONI

ROTARY VANES VACUUM PUMP / POMPA A PALETTE PER VUOTO / PRESSIONE

**MEC 9000 11000 13500**

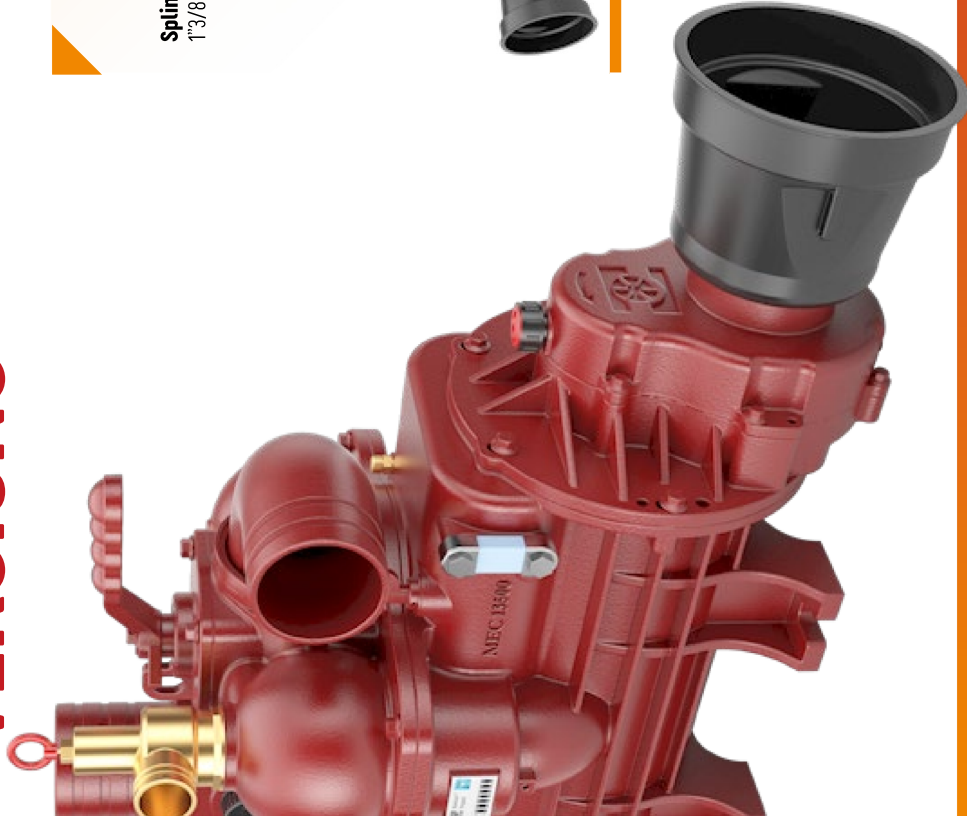

## MEC/M-MA

**Splined shaft**/Albero scanalato:  
1 3/8 - Z6 ISO 500

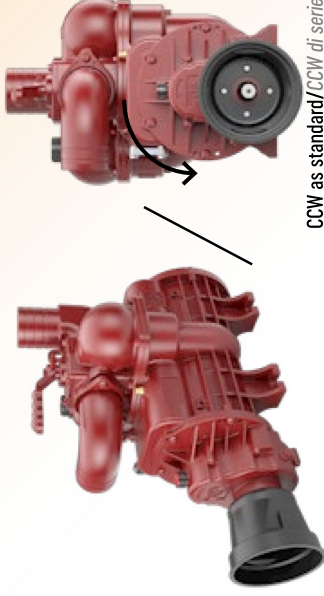

CCW as standard / CCW di serie

## MEC/P

**Smooth cylindrical shaft**/Albero cilindrico liscio: Ø 32  
Length/Lunghezza: 63 mm  
**Parallel key**/Chiave parallela: UNI 6604

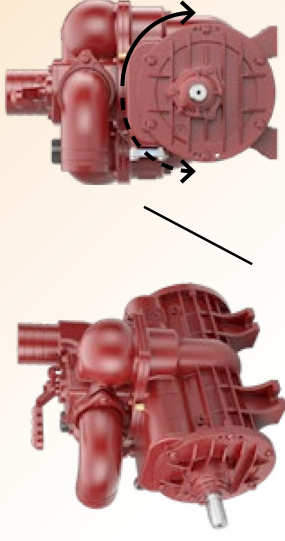

CW as standard - CCW on request / CW di serie - CCW su richiesta

## STANDARD FEATURES | CARATTERISTICHE STANDARD

- ▶ Long Life Blades, Crash Protection System, forced lubrication, external oil level indicator, side outlets, exhaust elbow, 4-ways valve, check valve
- ▶ Available hoses connections: Ø 76 mm [3"] / Ø 80 mm / Ø 100 mm [4"]
- ▶ Thread for Overpressure valve: G 2"
- ▶ Palette "long life", Crash Protection System, Pompa di lubrificazione forzata, indicatore di livello olio esterno, uscite laterali, scarico a gomito, Valvola 4 vie, valvola di ritegno.
- ▶ Collegamenti tubi disponibili: Ø 76 mm [3"] / Ø 80 mm / Ø 100 mm [4"]
- ▶ Thread for Overpressure valve: G 2"



**Battioni®  
Pagani**

*Setting the pace since 1953*

# VERSIONS | VERSIONI

ROTARY VANES VACUUM PUMP / POMPA A PALETTE PER VUOTO / PRESSIONE

**MEC 9000 11000 13500**

## MEC/D

**Splined shaft** / Albero scanalato:  
1"3/8 - Z6 ISO 500

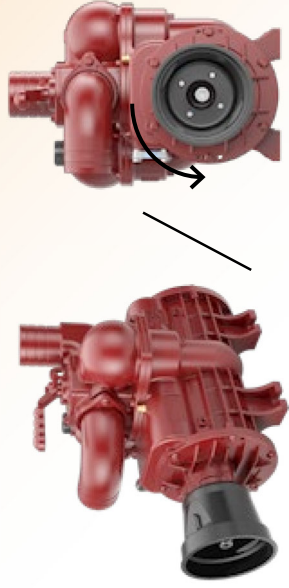

CCW as standard / CCW di serie

## MEC/HM

**MEC 9000:** 100 cc/rev • Pmax 175 bar • In G 1/2" • Out G 1/2"  
**MEC 11000:** 125,7 cc/rev • Pmax 175 bar • In G 1/2" • Out G 1/2"

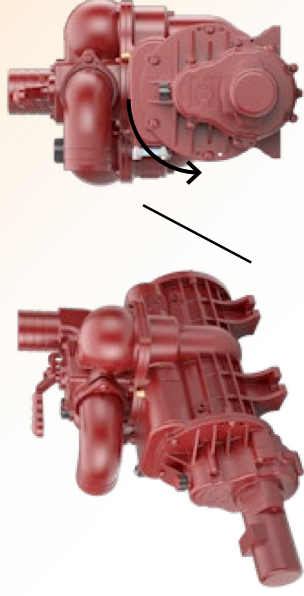

CCW as standard / CCW di serie

## MEC/H

**MEC 9000:** Group 3,5 51,83 cc/rev • Pmax 230 bar • In G 1" • Out G 1"  
**MEC 11000:** Group 3,5 73,82 cc/rev • Pmax 180 bar • In G 1" • Out G 1" 1/4  
**MEC 13500:** Group 4 86,56 cc/rev • Pmax 280 bar • In G 1" 1/4 • Out G 1" 1/2

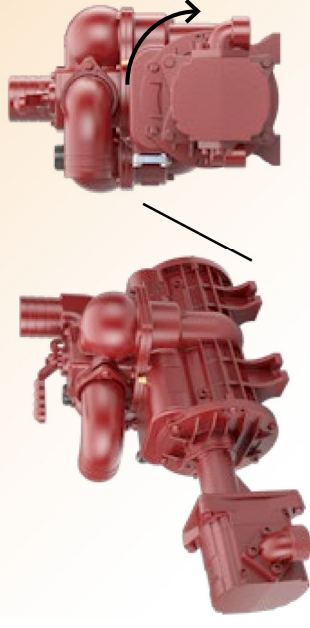

CW as standard / CW di serie



**Battioni®  
Pagani**

*Setting the pace since 1953*

# OPTIONALS | OPZIONALI

**MEC 9000 11000 13500**



**EXTRA SIDE TANK/ SERBATOIO LATERALE EXTRA**  
 Code/Codice: 6080200304 (LA)  
 Code/Codice: 6080200310 (LF)



**AUTOMATIC LUBRICATION/ LUBRIFICAZIONE AUTOMATICA**  
 Double lubrication point/ Punto di lubrificazione doppio



**SIDE OUTLET/ USCITA LATERALE**  
 Ø76/80/100 mm  
 With two revolving elbows/ Con due gomiti girevoli



**DOUBLE OUTLET/ DOPPIA USCITA**  
 Ø80 mm



**KIT VACUUM RELIEF VALVE FOR REVOLVING ELBOW/ KIT VALVOLA LIMITATRICE DI VUOTO PER GOMITO GIREVOLE**  
 Code/Codice: 6080200181



**HYDRAULIC CHANGEOVER/ CAMBIO IDRAULICO**  
 Code/Codice: 6080200176

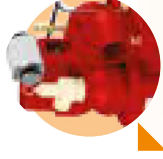

**PNEUMATIC REVOLVING CHANGEOVER/ CAMBIO PNEUMATICO GIREVOLE**  
 Code/Codice: 6080200238



## PUMP ACTIVE CONTROLLER

Electronic device designed to monitor the operating conditions of the pump/Dispositivo elettronico per regolazione e il monitoraggio delle condizioni di funzionamento della pompa

Data storage on Cloud/Archivio dei dati su Cloud

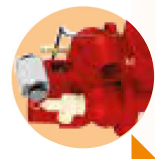

**HYDRAULIC REVOLVING CHANGEOVER/ CAMBIO IDRAULICO GIREVOLE**  
 Code/Codice: 5090000078



**PNEUMATIC REVOLVING CHANGEOVER/ 3 POSITIONS/ KIT CILINDRO ROTATIVO PNEUMATICO 3 POSIZIONI**  
 Code/Codice: 6080200238



**KIT ALUMINUM FINAL AIR FILTER 1300 SELF CLEANING/ FILTRO ASPIRAZIONE ARIA COMPLETO COLLETTORE 1300**  
 Code/Codice: 6080200290



**FLUSHING KIT/ FLUSHING KIT**  
 Code/Codice: 6080200325



**BATTIONI PAGANI VACUUM PUMP OIL/ BATTIONI PAGANI VACUUM PUMP OIL**  
 5 Lt  
 Code/Codice: 5070200100



**BATTIONI PAGANI FLUSHING FLUID/ BATTIONI PAGANI FLUSHING FLUID**  
 5 Lt  
 Code/Codice: 5070200102

**CUSTOMIZED PAINTING COLORI PERSONALIZZATI**

### Main functions:

- Setting discharge pressure during emptying operations
- Constant monitoring and recording of pump data parameters
- Automatic washing of pump's rotors
- Automatic protection against overheating of the pump

### Principali funzioni:

- Regolazione della pressione di scarico durante lo svuotamento della cisterna
- Costante controllo e registrazione dei parametri di funzionamento
- Lavaggio dei rotori automatico
- Protezione contro surriscaldamento della pompa



USB port/ Porta USB



GPRS and modem/ GPRS e modem



**Battioni® Pagani**

Setting the pace since 1953

# ACCESSORIES | ACCESSORI

ROTARY VANES VACUUM PUMP / POMPA A PALETTE PER VUOTO / PRESSIONE

**MEC 9000 11000 13500**

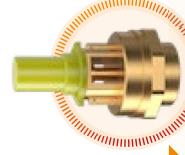
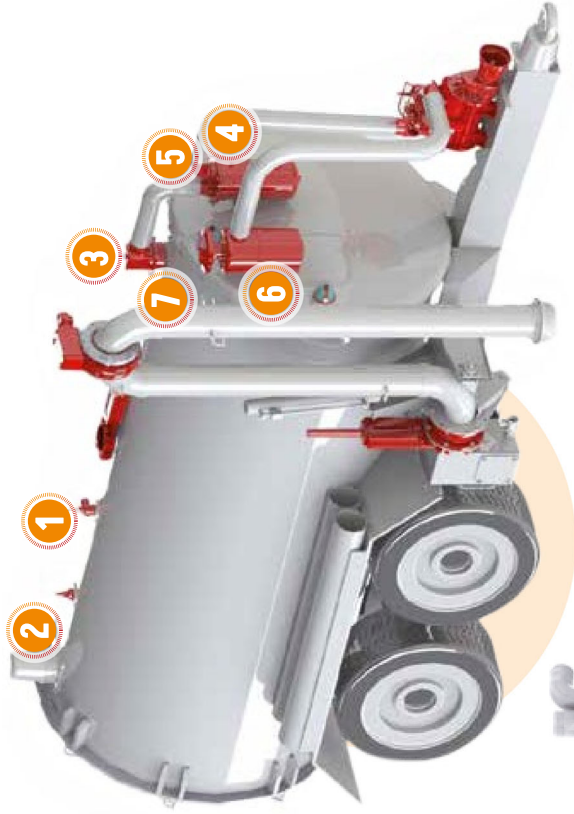

**1**  
**VACUUM RELIEF VALVE/  
VALVOLA LIMITATRICE  
DI VUOTO  
1"1/2**

► **Code/ Codice:** 5100200012  
**Setting range/ Settaggio:**  
-0,3 bar/+0,8 bar  
**Working temperature/  
Temperatura di lavoro:**  
-20°C/+90°C  
**Thread/ Filetto:** 6 1/2  
**Weight/ Peso:** 0,65 Kg

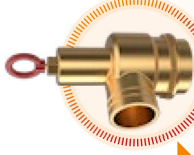

**2**  
**OVERPRESSURE  
SAFETY VALVE/VALVOLA  
DI SICUREZZA PER  
SOVRAPRESSIONE 2"**

► **Code/ Codice:** 5100200011  
**Setting range/ Settaggio:**  
+0,3 bar/+1,5 bar  
**Working temperature/  
Temperatura di lavoro:**  
-20°C/+90°C  
**Thread/ Filetto:** 6 2"  
**Weight/ Peso:** 1,2 Kg

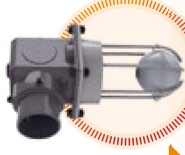

**3A**  
**PRIMARY OVERFLOW  
VALVE ONE SS BALLS/  
VALVOLA DI TROPPO PIENO  
A UNA SFERA SS**

► **Code/ Codice:**  
**Ø 80SS:** 6100200027  
**Ø 100SS:** 6100200028  
**Ball material:** AISI 316/Materiale  
della sfera: AISI 316  
**Weight iron ring to be welded/  
Peso anello in ferro da saldare:**  
13,8/13,9 Kg

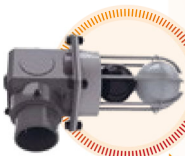

**3B**  
**PRIMARY OVERFLOW  
VALVE TWO BALLS/  
VALVOLA DI TROPPO PIENO  
A DUE SFERE**

► **Code/ Codice:**  
**Ø 76:** 6100200030  
**Ø 80:** 6100200025  
**Ø 100:** 6100200026  
**Weight iron ring to be welded/  
Peso anello in ferro da saldare:**  
13,9/14,0 Kg

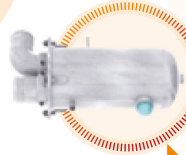

**4**  
**SECONDARY VALVE-TWO  
BALLS/VALVOLA  
SECONDARIA-DUE SFERE**

► **Code/ Codice:**  
**Ø 76:** 6100200035  
**Ø 80:** 6100200021  
**Ø 100:** 6100200022  
**Weight  
/Peso:**  
35,6 Kg

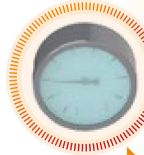

**5A**  
**GAUGE AXIAL  
CONNECTION/MANOMETRO  
CON ATTACCO ASSIALE  
Ø80 mm**

► **Code/ Codice:** 510700007  
**To be fitted on secondary valve/  
Da montare sulla valvola secondaria**



**5B**  
**DISCHARGE VALVE/  
VALVOLA DI SCARICO  
1"**

► **Code/ Codice:** 5040200014  
**To be fitted on secondary valve/  
Da montare sulla valvola secondaria**



**6**  
**FILTER SILENCER/  
SILENZIATORE FILTRO**

► **Code/ Codice:**  
**MEC 9000/11000-Ø80:**  
5090000025  
**MEC 13500-Ø100:** 5090000026  
**Weight/ Peso:** 9,5/13 Kg



**7A**  
**RAIN CAP/RAIN CAP**

► **Code/ Codice:**  
**MEC 9000/11000-Ø80:**  
5090000061  
**MEC 13500-Ø100:** 5090000062  
**Weight/ Peso:** 0,4 Kg

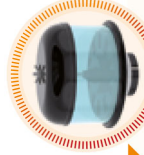

**7B**  
**PRE-FILTER/  
PRE-FILTER**

► **Code/ Codice:**  
**MEC 9000/11000-Ø80:**  
5090000046  
**MEC 13500-Ø100:** 5090000047



**Battioni®  
Pagani**

*Setting the pace since 1953*

# MEC 16500

The MEC 16500 pump represents a technology breakthrough resulted from a **major joint effort in product development and innovative design processes.**

La pompa MEC 16500 rappresenta una svolta tecnologica, risultato di uno sforzo congiunto nello sviluppo del prodotto e di innovativi processi di progettazione.

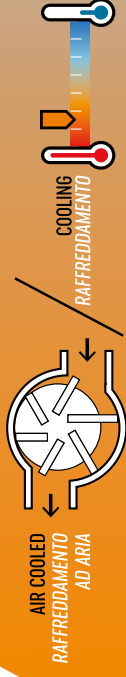

The picture is only for informative purposes. The picture is only for informative purposes.



**Battioni®  
Pagnani**

*Setting the pace since 1953*

# VERSIONS | VERSIONI

ROTARY VANES VACUUM PUMP / POMPA A PALETTE PER VUOTO / PRESSIONE

## MEC 16500

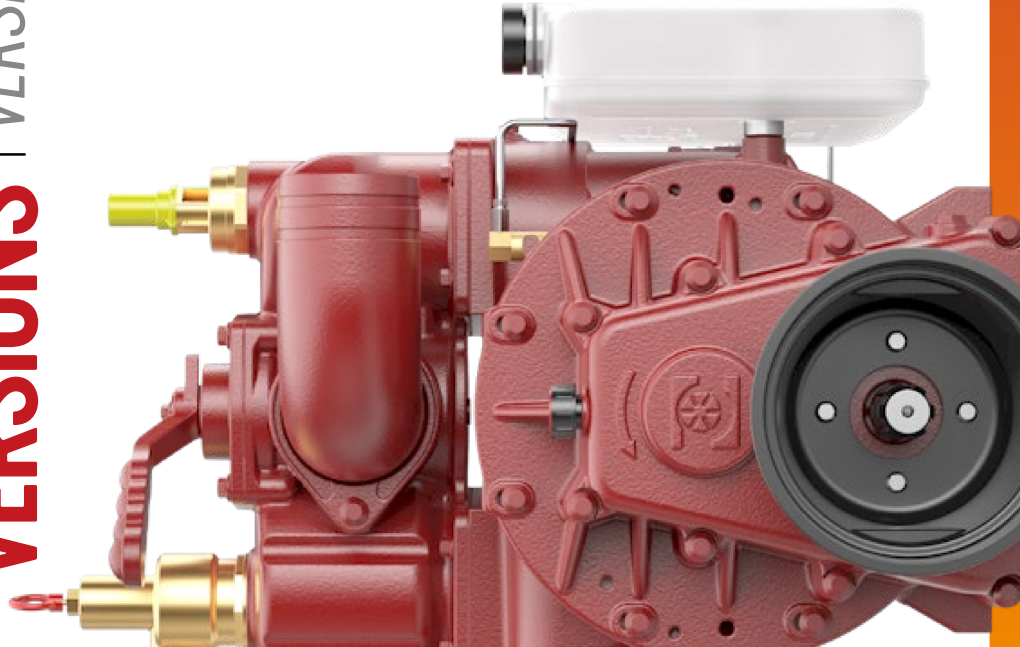

### MEC/M-MA

**Splined shaft** / Albero scanalato:  
1 3/8 - Z6 ISO 500

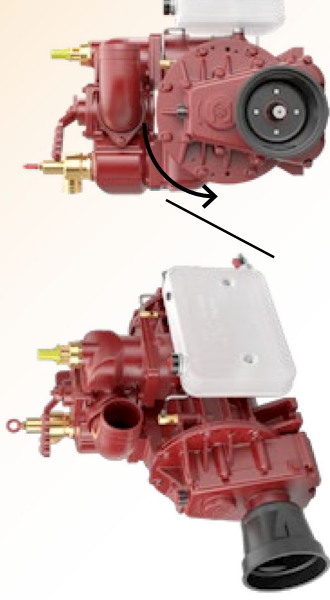

CCW as standard / CCW di serie

### MEC/P

**Smooth Cylindrical shaft** / Albero cilindrico liscio:  $\varnothing 40$   
Length / Lunghezza: 89 mm  
**Parallel key** / Chiave parallela: UNI 6604

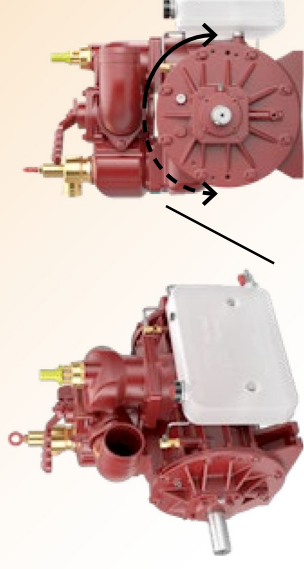

CW as standard - CCW on request / CW di serie - CCW su richiesta

### STANDARD FEATURES | CARATTERISTICHE STANDARD

- ▶ Crash Protection System, Automatic lubrication, External Side oil tank, 4-ways valve
- ▶ Available hoses connections:  $\varnothing 100$  mm (4")
- ▶ Crash protection system, lubrificazione automatica, serbatoio olio esterno, valvola 4 vie
- ▶ Collegamenti tubi disponibili:  $\varnothing 100$  mm (4")



**Battioni®  
Pagani**

*Setting the pace since 1953*



# VERSIONS | VERSIONI

ROTARY VANES VACUUM PUMP / POMPA A PALETTE PER VUOTO / PRESSIONE

## MEC 16500

### MEC/D

**Splined shaft** / Albero scanalato:  
1"3/8 - Z6 ISO 500



CCW as standard / CCW di serie

### MEC/H

**Group 4**  
86.56 cc/rev • Pmax 280 bar • In G 1" 1/4 • Out G 1" 1/2

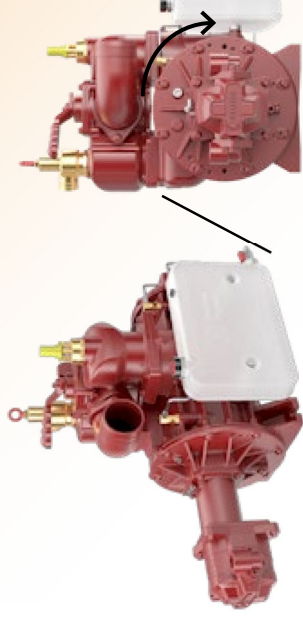

CCW as standard / CCW di serie

### MEC/K-KA

**Splined shaft** / Albero scanalato: 1"3/8 - Z6 ISO 500  
**Support** / Supporto: Gr. 2 or Gr. 3  
(Hydraulic pump on request / Pompa idraulica su richiesta)

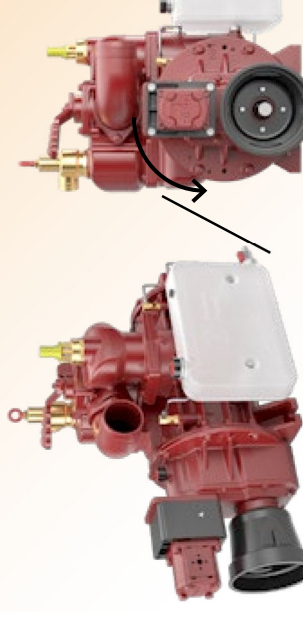

CCW as standard / CCW di serie



**Battioni®  
Pagani**

*Setting the pace since 1953*

# OPTIONALS | OPZIONALI



**HYDRAULIC  
CHANGEOVER/  
CAMBIO  
IDRAULICO**

Code/Codice: 6080200315



**PNEUMATIC  
REVOLVING  
CHANGEOVER/  
CAMBIO  
PNEUMATICO**

Code/Codice: 6080200306



**HYDRAULIC  
REVOLVING  
CHANGEOVER/  
CAMBIO  
IDRAULICO**

Code/Codice: 5090000108

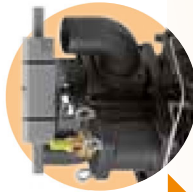

**PNEUMATIC REVOLVING  
CHANGEOVER 3  
POSITIONS/  
POSIZIONI  
PNEUMATICO  
3 POSIZIONI**

Code/Codice: 6080200307



**KIT ALUMINUM FINAL  
AIR FILTER 1300  
SELF CLEANING/  
FILTRO ASPIRAZIONE  
ARIA COMPLETO  
COLLETTORE 1300**

Ø100  
Code/Codice: 6080200426



**FLUSHING KIT/  
FLUSHING KIT**

Code/Codice: 6080200325



**BATTIONI PAGANI  
VACUUM  
PUMP OIL/  
BATTIONI PAGANI  
VACUUM PUMP OIL**

5 Lt  
Code/Codice: 5070200100



**BATTIONI PAGANI  
FLUSHING FLUID/  
BATTIONI PAGANI  
FLUSHING FLUID**

5 Lt  
Code/Codice: 5070200102

MEC 16500

## PUMP ACTIVE CONTROLLER



Electronic device designed to monitor the operating conditions of the pump/Dispositivo elettronico per regolazione e il monitoraggio delle condizioni di funzionamento della pompa

Data storage on Cloud/Archivio dei dati su Cloud

### Main functions:

- ▶ Setting discharge pressure during emptying operations
- ▶ Constant monitoring and recording of pump data parameters
- ▶ Automatic washing of pump's rotors
- ▶ Automatic protection against overheating of the pump

### Principali funzioni:

- ▶ Regolazione della pressione di scarico durante lo svuotamento della cisterna
- ▶ Costante controllo e registrazione dei parametri di funzionamento
- ▶ Lavaggio dei rotori automatico
- ▶ Protezione contro surriscaldamento della pompa



USB port/ Porta USB



GPRS and modem/ GPRS e modem

**CUSTOMIZED  
PAINTING  
COLORI  
PERSONALIZZATI**



Setting the pace since 1953

# ACCESSORIES

## ACCESSORI

ROTARY VAINES VACUUM PUMP / POMPA A PALETTE PER VUOTO / PRESSIONE

# MEC 16500

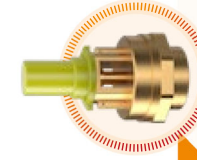
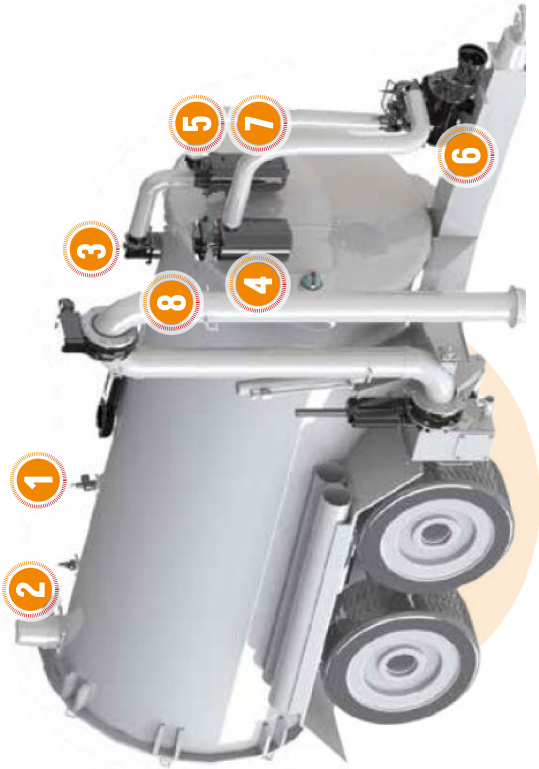

**1**  
**VACUUM RELIEF VALVE / VALVOLA LIMITATRICE DI VUOTO 1"1/2**

Code/Codice: 5100200012  
Setting range/Settingaggio: -0,3 bar/-0,8 bar  
Working temperature/Temperatura di lavoro: -20°C/+90°C  
Thread/Filetto: 6 1/12  
Weight/Peso: 0,65 Kg

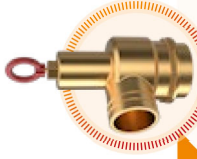

**2**  
**OVERPRESSURE SAFETY VALVE / VALVOLA DI SICUREZZA PER SOVRAPRESSIONE 2"**

Code/Codice: 5100200011  
Setting range/Settingaggio: +0,3 bar/+1,5 bar  
Working temperature/Temp. di lavoro: -20°C/+90°C  
Thread/Filetto: 6 2"  
Weight/Peso: 1,2 Kg

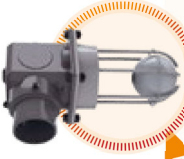

**3A**  
**PRIMARY OVERFLOW VALVE ONE SS BALLS / VALVOLA DI TROPPO PIENO A UNA SFERA SS**

Code/Codice: 6100200027  
Ø 80SS: 6100200028  
Ø 100SS: 6100200028  
Ball material: AISI 316 / Materiale della sfera: AISI 316  
Weight iron ring to be welded / Peso anello in ferro da saldare: 13,8/13,9 Kg



**3B**  
**PRIMARY OVERFLOW VALVE TWO BALLS / VALVOLA DI TROPPO PIENO A DUE SFERE**

Code/Codice: 6100200030  
Ø 76: 6100200030  
Ø 80: 6100200025  
Ø 100: 6100200026  
Weight iron ring to be welded / Peso anello in ferro da saldare: 13,9/14,0 Kg



**4**  
**FILTER SILENCER / SILENZIATORE FILTRO**

Code/Codice: 5090000026  
Hose connection/Connettore tubo: Ø 100 mm  
Weight/Peso: 9,5/13 Kg



**5A**  
**GAUGE AXIAL CONNECTION / MANOMETRO CON ATTACCO ASSIALE Ø80 mm**

Code/Codice: 5101700007  
To be fitted on secondary valve / Da montare sulla valvola secondaria

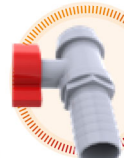

**5B**  
**DISCHARGE VALVE / VALVOLA DI SCARICO**

Code/Codice: 5040200014  
1": 5040200016  
To be fitted on secondary valve / Da montare sulla valvola secondaria



**6**  
**PULLEY WITH PNEUMATIC CLUTCH / PULEGGIA CON FRIZIONE PNEUMATICA**

Code/Codice: 6080200034

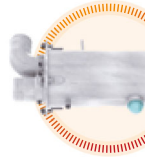

**7A**  
**SECONDARY VALVE - TWO BALLS / VALVOLA SECONDARIA - DUE SFERE**

Code/Codice: 6100200035  
Ø 76: 6100200035  
Ø 80: 6100200021  
Ø 100: 6100200022  
Weight/Peso: 35,6 Kg

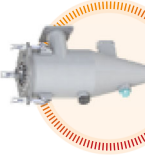

**7A**  
**CYCLON VALVE / VALVOLA CICLONE 1100-Ø100**

Code/Codice: 6100200033  
Weight/Peso: 35 Kg  
Housing: galvanized mild steel / Contenitore: acciaio dolce zincato  
Cover: aluminum / Materiale: alluminio



**8A**  
**RAIN CAP / RAIN CAP**

Code/Codice: 5090000062  
Weight/Peso: 0,4 Kg



**8A**  
**PRE-FILTER / PRE-FILTER**

Code/Codice: 5090000047



**Battioni®  
Pagani**

Setting the pace since 1953

# TECHNICAL DATA | DATI TECNICI

ROTARY VANES VACUUM PUMP / POMPA A PALETTE PER VUOTO / PRESSIONE

**MEC 9000 | 11000 | 13500 | 16500**

MODELS MODELLI	GEOMETRICAL CAPACITY GEOMETRICAL CAPACITY		MAX RPM MAX RPM			MAX PRESSURE ABS PRESSIONE ABS Bar (PSI)	MAX VACUUM % MAX VACUUM % inHg	MAX CONTINUOUS VACUUM % MAX CONTINUOUS VACUUM % inHg	POWER AT MAX VACUUM POWER AT MAX VACUUM kW (hp)	WEIGHT/PESO Kg								
	m <sup>3</sup> /h	l/min	M	HM	K					MA	KA	P/D/H	M/MA	P	D	H	HM	K/KA
<b>MEC 9000</b>	5418	9030	319	600	600	1000	1000	1400	2,5 (36)	95% (28.5")	60% (18")	17 (22.8)	145	131	132	154	146	/
<b>MEC 11000</b>	6682	11137	393	600	600	1000	1000	1400	2,5 (36)	95% (28.5")	60% (18")	21 (28.2)	160	146	147	170	161	/
<b>MEC 13500</b>	830,7	13945	489	600	600	1000	1000	1400	2,5 (36)	95% (28.5")	60% (18")	25 (33.5)	178	164	165	205	205	/
<b>MEC 16500</b>	1008	16800	593	600	600	1000	1000	1400	2,5 (36)	95% (28.5")	60% (18")	24 (32.2)	244	235	235	244	244	/

The MEC features the **Crash Protection System**: a sliding flanges protection mechanism that prevents the housing or rotor to break of in case of vanes crash. The pump is easily repairable inexpensively in field.

La pompa MEC è dotata di **Crash Protection System**: un meccanismo di protezione a flange scorrevoli che impedisce all'alloggiamento o al rotore di subire danni in caso di rottura delle palette. La pompa è quindi facilmente ed economicamente riparabile in campo.



Battioni®  
Pagani  
Setting the pace since 1953

## PRODUCT COMPLIANCE INFORMATION

Battioni Pagani® vacuum / pressure blower pumps are designed and manufactured in compliance with EU safety regulations and are assessed against risks according to the standard **UNI EN ISO 12100:2010**, in particular they conform to directive 2006/42/CE and subsequent modifications and additions. The design of this pump complies with the definition of "machine" as contained in the **Machinery Directive 2006/42/EC**. The pump carries the CE mark on its identification plate.

## DISCLAIMER NOTICE

The information contained in this technical catalogue is up-to-date and valid at the date of its issue as stated in this page. Battioni Pagani® does not have control over the specific usage intent nor can predict all application conditions under which this product may be used. Therefore, the user shall carefully review the information contained herein and consider it within the specific context of its planned installation and use.

In no event, Battioni Pagani® shall be liable for any loss or damage directly or indirectly arising from any person's use or inability to use this technical catalogue and the product herein described either separately or in combination with other equipment. Other than warranties implied by law, no express or implied warranties are granted including the implied warranty of fitness for a particular purpose.

## INFORMAZIONI SULLA CONFORMITÀ DEL PRODOTTO

Le pompe per vuoto / pressione Battioni Pagani® sono progettate e prodotte in conformità con le normative di sicurezza dell'UE e seguendo i principi di valutazione dei rischi previsti dalla norma **UNI EN ISO 12100: 2010**, in particolare sono conformi alla direttiva 2006/42 / CE e successive modifiche e integrazioni. Il design di questa pompa è conforme alla definizione di "macchina" contenuta nella **Direttiva Macchine 2006/42/CE**. La pompa riporta il marchio CE sulla targhetta di identificazione.

## DISCLAIMER

Le informazioni contenute in questo catalogo tecnico sono aggiornate e valide alla data di emissione indicata in questa pagina. Battioni Pagani® non ha il controllo sugli utilizzi specifici né può prevedere tutte le condizioni in cui questo prodotto può essere utilizzato. Pertanto, l'utente deve esaminare attentamente le informazioni contenute nel presente documento e considerarle nel contesto specifico di installazione e utilizzo previsti.

In nessun caso Battioni Pagani® sarà responsabile per eventuali perdite o danni direttamente o indirettamente derivanti dall'uso o dall'incapacità di utilizzo di questo catalogo tecnico e del prodotto qui descritto, separatamente o in combinazione con altro equipaggiamento. Oltre alle garanzie implicite per legge, non vengono concesse garanzie esplicite o implicite, inclusa la garanzia implicita di idoneità per uno scopo particolare.

## CONTACT | CONTATTI

For the latest specification, additional product information, worldwide sales and distributions locations please contact: / Per le specifiche più recenti, ulteriori informazioni su Battioni Pagani® e i propri prodotti, sedi di vendita e distribuzione nel mondo e per domande tecniche contattare:

▶ [info@bapag.it](mailto:info@bapag.it)

For technical questions and application information: / Per informazioni tecniche su prodotti e applicazioni:

▶ [service@bapag.it](mailto:service@bapag.it)

[www.bapag.it](http://www.bapag.it)