

7026965 - NORSUP HEAT PUMP, TYPE PV INVERTER (TYPE P13V/32)

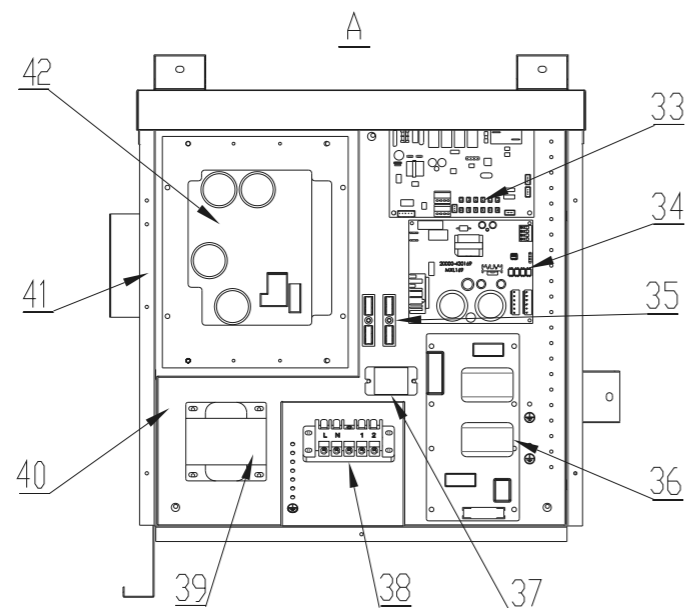
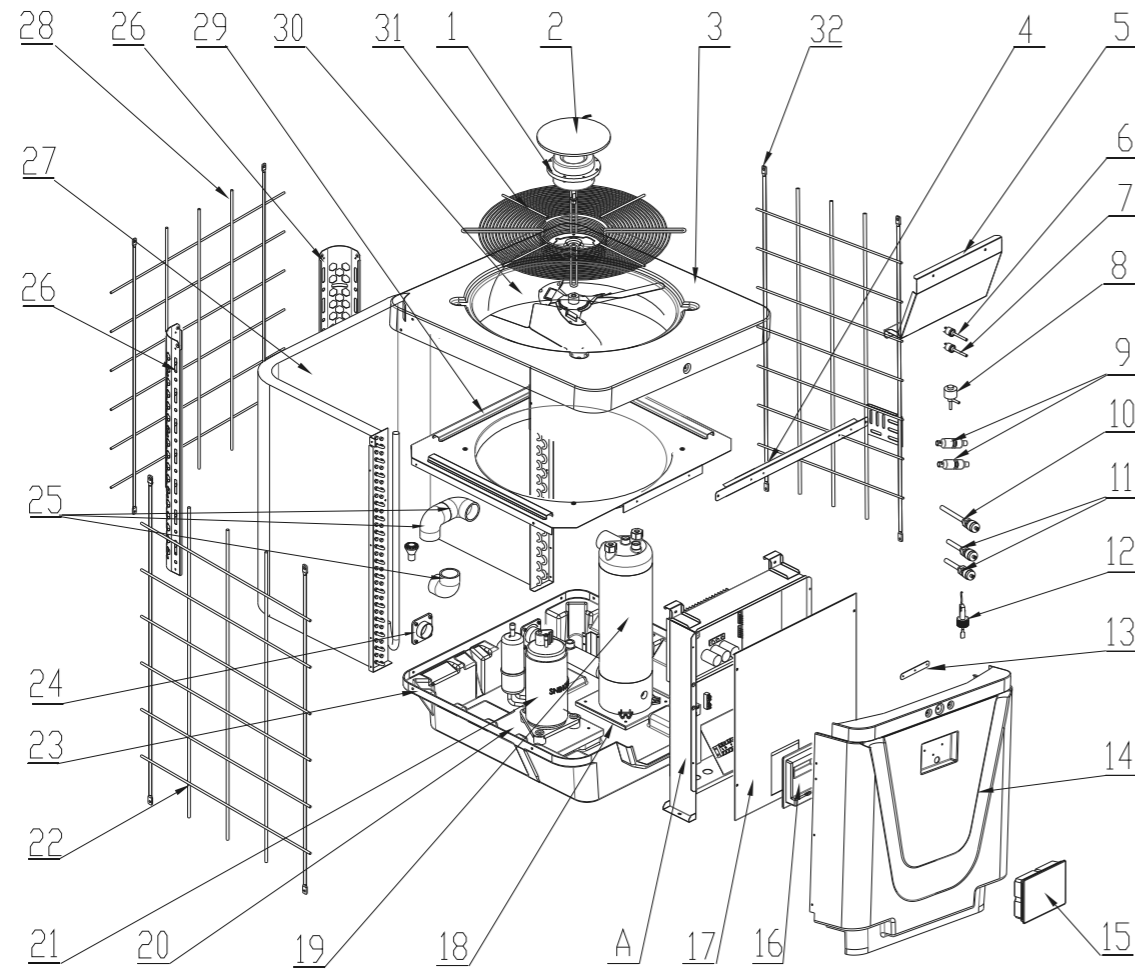

7026965 - NORSUP HEAT PUMP, TYPE PV INVERTER (TYPE P13V/32)

NR.	DESCRIPTION	PART NR.
1	Fan motor 200W ZWS200-B3	7027686
2	Cover plate	
3	Top cover	
4	Stabilizer	
5	Fan protection plate	
6	High pressure switch 3.2MPa/4.4MPa	7011008
7	Low pressure switch 0.3MPa/0.15MPa	7011009
8	Electronic expansion valve	
9	Filter	
10	Needle valve(1)	
11	Needle valve(2)	
12	Water flow switch with glue adapter 32 mm	7006471
13	Surface box fixed plate	
14	Front pannel	
15	Colorful display 20000-430176-8200047	7024942
16	Junction box body	
17	Electrical box support plate	
18	Titanium pipe support	
19	heat exchanger P13V/32	7027690
20	Compressor bracket	
21	Compressor SVB220FLGMC-L	
22	Middle Protection net	
23	Chassis	
24	Water connection	
25	Fittings	
26	Rear support column	
27	Evaporator	
28	Back protect net	
29	Top support plate	
30	Fan blade 522mm x 140mm, 12,7 hole anticlockwise (3 leaf)	7027709
31	Fan net	
32	Left&Right protection net	
33	PC1004 PCB controller 72200033-20000-430227 type P13V/32	7027668
34	Fan speed control module 20000-430228+35005-310617	7027685
35	2-way wire connector	7011019
36	Filter plate AC19I32.RWL.150813	7027682
37	Relay	
38	5-way wire connector	7011025
39	Reactance	
40	Support frame	
41	Support plate	
42	Inverter driver board 2AC81I01WM1	7027678
	Temperature sensor(5K)	7011007
	Exhausted temperature sensor 50K	7024867
	Pressure meter 0-55bar gas R 32 (-15°C)Pressure gage	7026259
	Mega Union coupler with O-ring PVC-U 50 mm x 1 1/2" glue socket x male thread 10bar grey	0100432
	Wifi module for Norsup PX, PV series	7027389
	10mtr extension cable + display housing Norsup PX/V-series	7025131
	winter cover 723x835x865 mm	7027696