

PRODUCT INFORMATION



Applications: screen filter with automatic hydraulic flushing

Standard Characteristics:

- **Filter element:** - ST.ST. screen AISI 316 mesh, supported by a PVC cylinder.
- **Available filtration:** 50-3000 micron
- **Filter housing material of construction:** Carbon Steel ST37.2
- **Pre-treatment:** sand blasting up to Sa 2.5 grade
- **Exterior & Interior coating:** electrostatic oven baked polyester-epoxy powder coating with a thickness of 150-200 micron
- **Connections:** VIC and Flange
- **Maximum recommended working pressure:** up to 10 bar (145 psi).
- **Minimum operating working pressure during flushing:** 2 bar (29 psi)
- Equipped with an electronic control system (6V DC, 12 V DC, 24V AC)

Operation:

The filter is equipped with a coarse screen that protects the finer screen from stones and larger particles. The coarse screen can be periodically clean manually. Automatic flushing of the fine screen is activated once the pressure differential (ΔP) in the filter reaches pre-determined value (up to 0.5 bar). During the flushing cycle, the flushing valve opens, pressure is released from the hydraulic piston and debris laden water is discharged through the flushing valve. Pressure in the hydraulic motor chamber and the dirt collector is significantly lowered causing the dirt collector nozzles move along and rotate cleaning the whole internal screen surface. The flushing cycle takes 5 seconds. The flushing valve closes at the end of the cycle, pressure reapplied to the piston, moving the nozzles back to their rest position, and the filter is cleaned. During the whole process water supply is uninterrupted.

Dimensions & Weight

Model	In/Out ØD (mm) (in)		ØD1 (in)	H (mm) (in)		X (mm) (in)		L (mm) (in)		L1 (mm) (in)		L2 (mm) (in)	
AF803NL	75	3	10	545	21.4	450	17.7	1139	44.8	1386	54.6	2040	80.3
AF804NL	100	4	10	545	21.4	900	35.4	1535	60.4	1782	70.1	2820	111.0
AF804NX	100	4	10	545	21.4	900	35.4	1931	76.0	2178	85.7	3620	142.5
AF806NL	150	6	12	580	22.8	900	35.4	1605	63.2	1851	72.9	2890	113.8
AF806NX	150	6	10	555	21.8	900	35.4	2001	78.8	2247	88.5	3680	144.9
AF808NR	200	8	12	579	22.8	900	35.4	1795	70.7	2041	80.4	3075	121.1
AF808NL	200	8	12	579	22.8	900	35.4	2190	86.2	2437	95.9	3870	152.4
AF810R	250	10	16	700	27.6	1100	43.3	1960	77.2	2405	94.7	3940	155.1
AF810NL	250	10	14	595	23.4	900	35.4	2194	86.4	2437	96.1	3870	152.4
AF810X	250	10	16	720	28.4	1100	43.3	2700	106.3	3145	123.8	5420	213.4
AF812R	300	12	16	720	28.4	1100	43.3	2700	106.3	3145	123.8	5420	213.4
AF814R	350	14	18	770	30.3	1270	50.0	2700	106.3	3145	123.8	5420	213.4
AF816R	400	16	18	770	30.3	1270	50.0	2700	106.3	3145	123.8	5420	213.4
AF816X	400	16	24	925	36.4	1270	50.0	2705	106.5	3150	124.0	5420	213.4

Flushing flow rate data is for minimum operational pressure (2 bar).

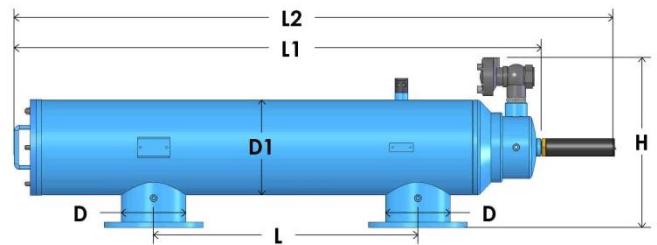
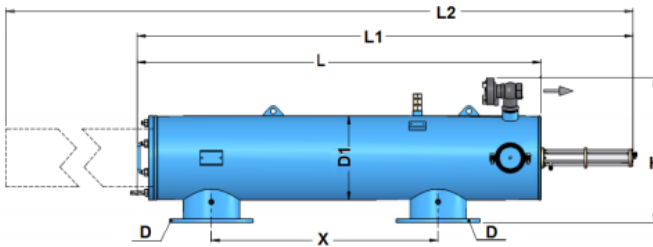

Model	In/Out ØD (mm) (in)		ØD1 (in)	Shipping Weight (kg) (lb)		Packaging volume LxWxH (m) (ft)	
	(mm)	(in)		(kg)	(lb)	(m)	(ft)
AF803NL	75	3	10	110	243	1.6x0.9x0.6	5.4x2.9x1.9
AF804NL	100	4	10	135	298	1.9x0.8x0.6	6.5x2.5x1.9
AF804NX	100	4	10	154	340	2.4x0.8x0.6	7.9x2.5x1.9
AF806NL	150	6	12	147	324	1.9x0.8x0.6	6.5x2.5x1.9
AF806NX	150	6	10	157	346	2.4x0.8x0.6	7.9x2.5x1.9
AF808NR	200	8	12	168	370	2.4x0.8x0.6	7.9x2.5x2.1
AF808NL	200	8	12	187	412	2.6x0.9x0.6	8.5x2.9x2.1
AF810R	250	10	16	316	697	2.9x1.0x0.6	9.4x3.3x1.9
AF810NL	250	10	14	212	467	2.6x0.9x0.6	8.5x2.9x2.1
AF810X	250	10	16	405	893	3.4x1.0x0.7	11.1x3.3x2.4
AF812R	300	12	16	410	904	3.4x1.0x0.7	11.1x3.3x2.4
AF814R	350	14	18	482	1063	3.4x1.0x0.7	11.1x3.3x2.4
AF816R	400	16	18	500	1102	3.4x1.0x0.7	11.1x3.3x2.4
AF816X	400	16	24	695	1532	3.4x1.2x0.9	11.1x3.9x3.2

Flow Rate

Model	In/Out ØD		Maximum Flow Rate		Screen area		Flushing Flow Rate		Flushing volume	
	(mm)	(in)	(m ³ /h)	(gpm)	(cm ²)	(in ²)	(m ³ /h)	(gpm)	(m ³)	(gal)
AF803NL	75	3	50	220	3220	500	30	132	0.083	21.9
AF804NL	100	4	80	350	5780	895	30	132	0.083	21.9
AF804NX	100	4	100	440	8410	1303	30	132	0.083	21.9
AF806NL	150	6	150	660	5780	895	30	132	0.083	21.9
AF806NX	150	6	160	700	8410	1303	30	132	0.083	21.9
AF808NR	200	8	250	1100	5780	895	30	132	0.083	21.9
AF808NL	200	8	300	1320	8410	1303	30	132	0.083	21.9
AF810R	250	10	350	1540	8090	1254	60	264	0.166	43.8
AF810NL	250	10	400	1760	8410	1304	30	132	0.083	21.9
AF810X	250	10	450	2000	11710	1815	90	396	0.249	65.7
AF812R	300	12	600	2640	11710	1815	90	396	0.249	65.7
AF814R	350	14	900	4000	12990	2013	90	396	0.249	65.7
AF816R	400	16	1100	4850	12990	2013	90	396	0.249	65.7
AF816X	400	16	1500	6600	17020	2638	90	396	0.249	65.7

Pressure Loss at 120 micron

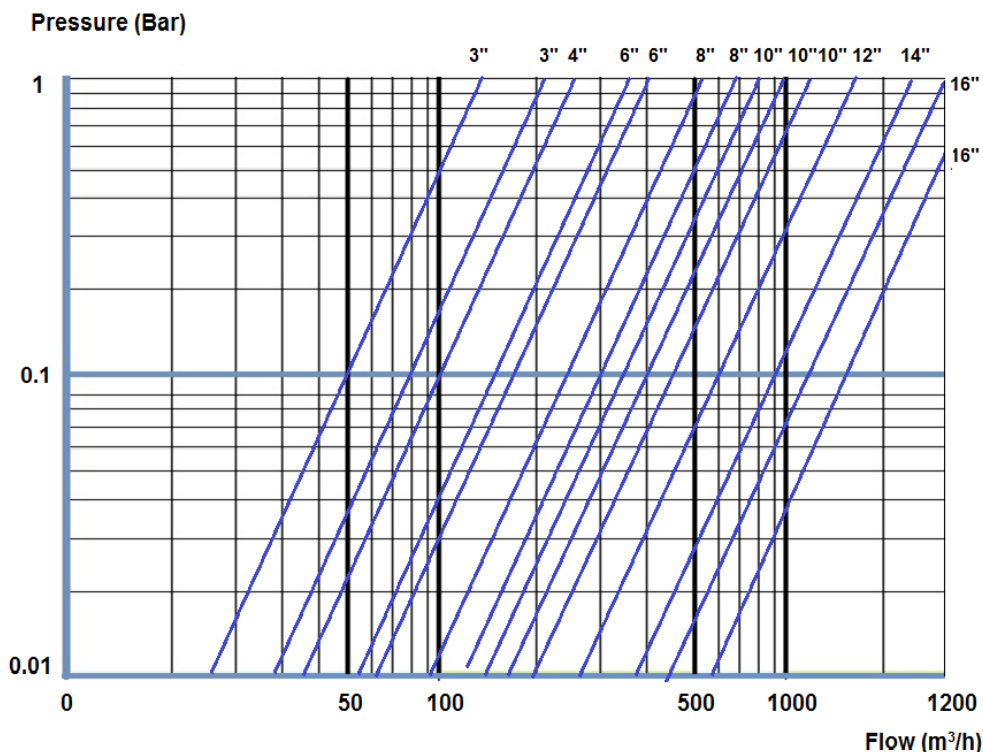

IPB	Model	Catalog No	Description
1	AF800N	N/A	FILTER BODY
2	AF800N	N/A	FILTER COVER
3	AF800N	5311250100	U-RING FOR COVER 10"-14"
4	AF803NL-808NL	5292143001-048	STUD 1/2"NC*48 SS304
	AF810NL	5292143001-055	STUD 1/2"NC*55 SS304
5	AF800NL	4121123001	WASHER M12 SS304
6	AF800NL	4112140401	NUT 1/2"NC HOT GALVANIZED
7	AF803NL	E7005600100-01	COARSE SCREEN PVC225 AF803L/4L/4X/N/903/4
	AF804NL		
	AF804NX		
	AF806NL	E7005600102-01	COARSE SCREEN PVC225 AF806X/6L/6XN/6LN
	AF806NX		
	AF808NR	E7005600104-01	COARSE SCREEN PVC225 AF808R/10L/8RN/10LN
	AF808NL		
AF810NL			
8	AF803NL	E7005602005-01##	COMP FINE SCREEN PVC225 AF803N
	AF804NL	E7005604003-01##	COMP FINE SCREEN PVC225 AF804NL/6NL/8NR
	AF806NL		
	AF808NR		
	AF804NX	E7005606000-01##	COMP FINE SCREEN PVC225 AF804NX/6NX/8NL/10NL
	AF806NX		
	AF808NL		
	AF810NL		
8.1	AF800N	4081202100-445	O-RING 445
8.2	AF800N	E5005600102-01##-02	FINE SCREEN UPPER SECTION PVC225 AF800N
8.2.1	AF800N	E5005600902-02	UPPER SCREEN ADAPTER PVC225 ASSM AF800N
8.2.1.1	AF800N	W5005600102-01##	FINE SCREEN UPPER SECTION PVC225
8.2.1.2	AF800N	5021640500	SCREEN WHEEL 225 NYLON
8.2.1.3	AF800N	5172391500	SCREEN BEARING F/DIRT COLLECTOR SHAFT AF800N
8.3	AF800N	W5005600300-01##	FINE SCREEN MIDDLE SECTION PVC225
9	AF800N	E5005601101-01	FLUSHING CHAMBER PVC225 AF800N/9800N
9.1	AF800N	W5005601101-01	FLUSHING CHAMBER PVC225 AF800N/9800N
9.2	AF800N	5172635000	DELTRIN BEARING FOR D/COLLECTOR 50 AF800N/9800N
10	AF803NL	E7102300201-01	COMP D/COLLECTOR 50 SS304 2 NOZZLE AF803NL
	AF804NL	E7102300401-01	COMP D/COLLECTOR 50 SS304 4 NOZZLE AF804NL-8NR
	AF806NL		
	AF808NR		
	AF804NX	E7102300601-01	COMP D/COLLECTOR 50 SS304 6 NOZZLE AF804NX-10NL
	AF806NX		
	AF808NL		
AF810NL			

IPB	Model	Catalog No	Description
10.1	AF800N	E5122670302	SUCTION NOZZLE (SADDLE) AF800N/9800N
11	AF803NL	E5142610200-01	COMP HYDRAULIC MOTOR PVC AF803NL
	AF804NL	E5142610200-02	COMP HYDRAULIC MOTOR PVC AF804NL/6NL/8NR
	AF806NL		
	AF808NR		
	AF804NX	E5142610200-03	COMP HYDRAULIC MOTOR PVC AF804NX/6NX/8NL/10NL
	AF806NX		
	AF808NL		
AF810NL			
11.1	AF800N	W5173390002-01	HEAD COLLECTOR BEARING BRASS AF800N/9800N
12	AF800N	E7160406300	HYD PISTON 40 DELRIN AF800N/9800N
12.1	AF800N	4081040100-223	O-RING 223
13	AF800N	E4510020003-07-1M	COMP HYDRAULIC VALVE DOROT GALIL 09AN 2"BSP
14	AF800N	E5412036301-01	SHORT DISTRIBUTOR DELRIN ASSM
14.1	AF800N	4081034100-126	O-RING 126
15	AF800N	CS11010015	PRESSURE GAUGE SET AF800/9800/500
16	AF800N	4640314002	PLUG 1/4" PLASTIC
17	AF800N	4640214082	MALE BRANCH T 8*1/4"*8 PLASTIC
18	AF800N	4640618082	MALE ELBOW 1/8"*8 PLASTIC
19	AF800N-DC	CSD1100112100	CONTROLLER 1-10 DC + 1 SOLENOID COMPLETE
	AF800N-AC	CSA1100114100	CONTROLLER 1-10 AC + 1 SOLENOID COMPLETE
19.1	AF800N-DC	4430010902	SOLENOID DCL GALSOL 2W
	AF800N-AC	4430030901	SOLENOID AC GALSOL 24V
19.2	AF800N-DC	4440211002	CONTROLLER 1-10 DC 2 PORTS + DP
	AF800N-AC	4440311002	CONTROLLER 1-10 AC 2 PORTS + DP
19.2.1	AF800N-DC	4450110200	EXPENSION CARD FOR 1-10 DC CONTROLLER
	AF800N-AC	4450110300	EXPENSION CARD FOR 1-10 AC CONTROLLER

Parts & Description – AF800 (3"-16")

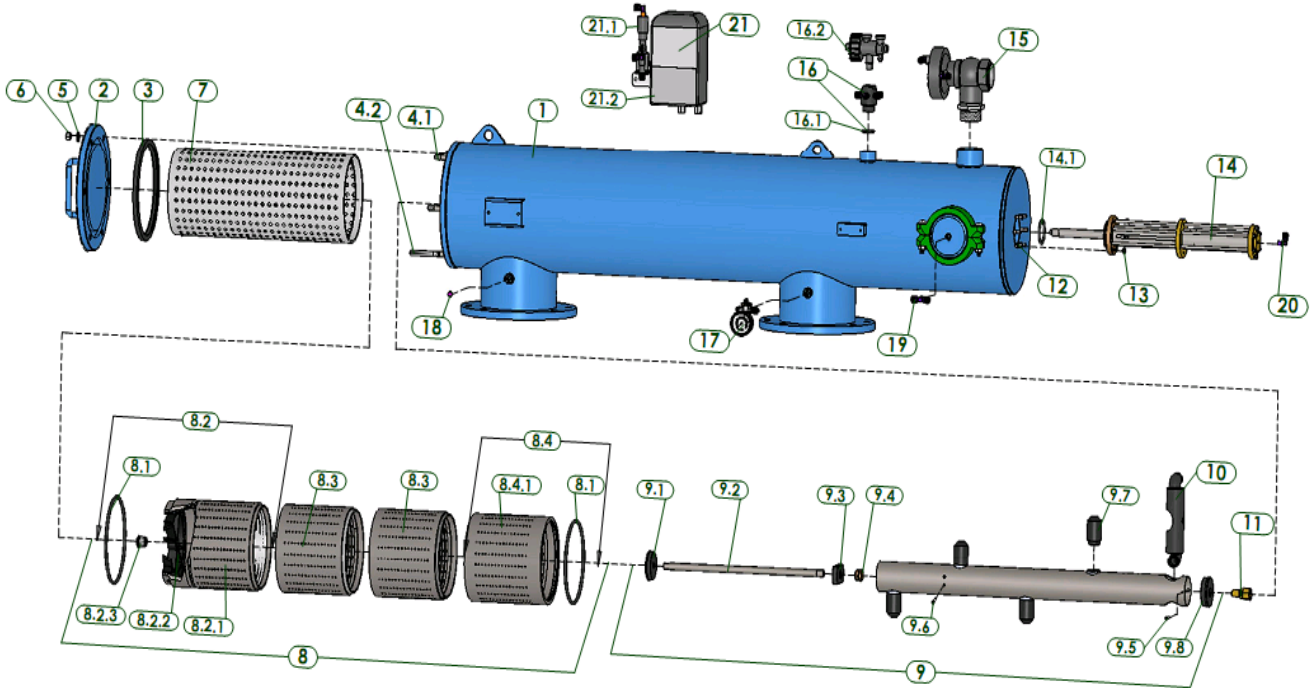

IPB	Model	Catalog No	Description
1	AF800	N/A	FILTER BODY
2	AF800	N/A	FILTER COVER
3	AF803L	5311250100	U-RING FOR COVER 10"-14"
	AF804L		
	AF806L		
	AF804X		
	AF806X		
	AF808L		
	AF808R	5311400100	U-RING FOR COVER 16"
	AF810L		
	AF810R		
	AF810X		
	AF812R	5311450100	U-RING FOR COVER 18"
	AF814R		
	AF816R		
	AF816X		
AF818X	5311600100	U-RING FOR COVER 24"	

IPB	Model	Catalog No	Description
4.1	AF803L	5292143001-048	STUD 1/2"NC*48 SS304
	AF804L		
	AF806L		
	AF804X		
	AF806X		
	AF808L		
	AF808R		
	AF810L	5292143001-055	STUD 1/2"NC*55 SS304
	AF810R	5292183001-073	STUD 3/4"NC*73 SS304
	AF810X		
	AF812R		
	AF814R		
	AF816R		
	AF816X	5292183001-080	STUD 3/4"NC*80 SS304
AF818X	5292183001-130	STUD 3/4"NC*130 SS304	
AF810R			
AF810X			
AF812R			
AF814R			
AF816R			
AF816X			
AF818X			
5	AF803L	4121123001	WASHER M12 SS304
	AF804L		
	AF806L		
	AF804X		
	AF806X		
	AF808L		
	AF808R		
	AF810L	4121203001	WASHER M20 SS304
	AF810R		
	AF810X		
	AF812R		
	AF814R		
	AF816R		
	AF816X		
AF818X			

IPB	Model	Catalog No	Description
6	AF803L	4112140401	NUT 1/2"NC HOT GALVANIZED
	AF804L		
	AF806L		
	AF804X		
	AF806X		
	AF808L		
	AF808R		
	AF810L	4112180401	NUT 3/4"NC HOT GALVANIZED
	AF810R		
	AF810X		
	AF812R		
	AF814R		
	AF816R		
	AF816X		
AF818X			
7	AF803L	E7005600100-01	COARSE SCREEN PVC225 AF803L/4L/4X/N/903/4
	AF804L		
	AF804X		
	AF806L	E7005600102-01	COARSE SCREEN PVC225 AF806X/6L/6XN/6LN
	AF806X		
	AF808L	E7005600104-01	COARSE SCREEN PVC225 AF808R/10L/8RN/10LN
	AF808R		
	AF810L	E7006600200-01	COARSE SCREEN PVC280 AF810R
	AF810R		
	AF810X	E7006600300-01	COARSE SCREEN PVC280 AF810X-12R
	AF812R		
	AF814R	E7007600300-01	COARSE SCREEN PVC315 AF814R-16R
	AF816R		
	AF816X	E7008600300-01	COARSE SCREEN PVC400 AF816X-18X
AF818X			
8	AF803L	E7005602006-02##	COMP FINE SCREEN PVC225 AF803L
	AF804L	E7005604004-01##	COMP FINE SCREEN PVC225 AF804L-8R
	AF806L		
	AF808R	E7005606001-01##	COMP FINE SCREEN PVC225 AF804X-10L
	AF804X		
	AF806X		
	AF808L		
	AF810L	E7006604000-01##	COMP FINE SCREEN PVC280 AF810R
	AF810R	E7006606000-01##	COMP FINE SCREEN PVC280 AF810X-12R
	AF810X		
	AF812R	E7007606000-01##	COMP FINE SCREEN PVC315 AF814R-16R
	AF814R		
	AF816R	E7008606001-01##	COMP FINE SCREEN PVC400 AF816X-18X
	AF816X		
AF818X			

IPB	Model	Catalog No	Description
8.1	AF803L	4081202100-445	O-RING 445
	AF804L		
	AF806L		
	AF804X		
	AF806X		
	AF808L		
	AF808R		
	AF810L	4081266100-450	O-RING 450
	AF810R		
	AF810X		
	AF812R	4081291100-452	O-RING 452
	AF814R		
	AF816R		
	AF816X	4081380100-459	O-RING 459
AF818X			
8.2	AF803L	E5005600102-01##-03	FINE SCREEN UPPER SECTION PVC225 ASSM803-10L/98N
	AF804L		
	AF806L		
	AF808R		
	AF804X		
	AF806X		
	AF808L		
	AF810L	E5006600100-01##-01	FINE SCREEN UPPER SECTION PVC280 ASSM AF810R-12R
	AF810R		
	AF810X		
AF812R	E5007600100-01##-01	FINE SCREEN UPPER SECTION PVC315 ASSM AF814R-16R	
AF814R			
AF816R	E5008600100-01##-01	FINE SCREEN UPPER SECTION PVC400 ASSM AF816X-18X	
AF816X			
AF818X			
8.2.1	AF803L	E5005600102-01##-06	FINE SCREEN UPPER SECTION PVC225
	AF804L		
	AF806L		
	AF804X		
	AF806X		
	AF808L		
	AF808R		
	AF810L	W5006600100-01##	FINE SCREEN UPPER SECTION PVC280
	AF810R		
	AF810X		
	AF812R	W5007600100-01##	FINE SCREEN UPPER SECTION PVC315
	AF814R		
	AF816R	W5008600100-01##	FINE SCREEN UPPER SECTION PVC400
	AF816X		
AF818X			

IPB	Model	Catalog No	Description
8.2.2	AF803L	5021640500	SCREEN WHEEL 225 NYLON
	AF804L		
	AF806L		
	AF804X		
	AF806X		
	AF808L		
	AF808R		
	AF810L	5021010600-P	SCREEN WHEEL 280 STEEL
	AF810R		
	AF810X		
	AF812R	5021010700-P	SCREEN WHEEL 315 STEEL
	AF814R		
	AF816R		
	AF816X	5021010800-P	SCREEN WHEEL 400 STEEL
AF818X			
8.2.3	AF800	5172301700	SCREEN BEARING F/SHAFT AF9/800/500B/700/9800N
8.3	AF803L	W5005600300-01##	FINE SCREEN MIDDLE SECTION PVC225
	AF804L		
	AF806L		
	AF804X		
	AF806X		
	AF808L		
	AF808R		
	AF810L	W5006600300-01##	FINE SCREEN MIDDLE SECTION PVC280
	AF810R		
	AF810X		
	AF812R	W5007600300-01##	FINE SCREEN MIDDLE SECTION PVC315
	AF814R		
	AF816R		
	AF816X	W5008600300-01##	FINE SCREEN MIDDLE SECTION PVC400
AF818X			
8.4.	AF803L	E5005600201-01##-01	FINE SCREEN LOWER SECTION PVC225 ASSM
	AF804L		
	AF806L		
	AF804X		
	AF806X		
	AF808L		
	AF808R		
	AF810L	E5006600200-01##-01	FINE SCREEN LOWER SECTION PVC280 ASSM
	AF810R		
	AF810X		
	AF812R	E5007600200-01##-01	FINE SCREEN LOWER SECTION PVC315 ASSM
	AF814R		
	AF816R		
	AF816X	E5008600200-01##-01	FINE SCREEN LOWER SECTION PVC400 ASSM
AF818X			

IPB	Model	Catalog No	Description
8.4.1	AF803L	W5005600201-01##	FINE SCREEN LOWER SECTION PVC225
	AF804L		
	AF806L		
	AF804X		
	AF806X		
	AF808L		
	AF808R		
	AF810L	W5006600200-01##	FINE SCREEN LOWER SECTION PVC280
	AF810R		
	AF810X		
	AF812R	W5007600200-01##	FINE SCREEN LOWER SECTION PVC315
	AF814R		
	AF816R	W5008600200-01##	FINE SCREEN LOWER SECTION PVC400
	AF816X		
AF818X			
9	AF803L	E7103610201-01	COMP D/COLLECTOR 2" PVC 2 NOZZLE AF803L
	AF804L	E7104610400-01	COMP D/COLLECTOR 75 PVC 4 NOZZLE AF804L-8R
	AF806L		
	AF808R		
	AF804X	E7106300600-01	COMP D/COLLECTOR 76 SS304 6 NOZZLE AF804X-10L
	AF806X		
	AF808L		
	AF810L		
	AF810R	E7105300400-01	COMP D/COLLECTOR 3" SS304 4 NOZZLE AF810R
	AF810X	E7105300600-01	COMP D/COLLECTOR 3" SS304 6 NOZZLE AF810X-12R
	AF812R		
	AF814R	E7105300601-01	COMP D/COLLECTOR 3" SS304 6 NOZZLE AF814R-16R
	AF816R		
AF816X	E7105300602-01	COMP D/COLLECTOR 3" SS304 6 NOZZLE AF816X-18X	
AF818X			
9.1	AF803L	5113610100	DIRT COLLECTOR 2" UPPER PLUG AF803L
	AF804L	5114610100	DIRT COLLECTOR 75 UPPER PLUG AF804L-8R
	AF806L		
	AF808R		
	AF804X	5116610100	DIRT COLLECTOR 76 UPPER PLUG AF804X-10L
	AF806X		
	AF808L		
	AF810L		
	AF810R	5115610100	DIRT COLLECTOR 3" UPPER PLUG AF810R-18X
	AF810X		
	AF812R		
	AF814R		
	AF816R		
	AF816X		
AF818X			

IPB	Model	Catalog No	Description
9.2	AF803L	5131391704	DIRT COLLECTOR SHAFT BRASS 17mm AF803
	AF804L	5131391703	DIRT COLLECTOR SHAFT BRASS 17mm AF804-10L
	AF806L		
	AF804X		
	AF806X		
	AF808L		
	AF808R		
	AF810L	5131391702	DIRT COLLECTOR SHAFT BRASS 17mm AF810R-18X
	AF810R		
	AF810X		
	AF812R		
	AF814R		
	AF816R		
	AF816X		
	AF818X		
9.3	AF804L	5114610300	DIRT COLLECTOR 75 MIDDLE PLUG AF804L-8R
	AF806L		
	AF808R		
	AF804X	5116610300	DIRT COLLECTOR 76 MIDDLE PLUG AF804X-10L
	AF806X		
	AF808L		
	AF810L	5115610300	DIRT COLLECTOR 3" MIDDLE PLUG AF810R-18X
	AF810R		
	AF810X		
	AF812R		
	AF814R		
	AF816R		
	AF816X		
AF818X			
9.4	AF804-18	5110390400	DIRT COLLECTOR SHAFT TIGHTENING NUT AF804-818
9.5	AF803L	4102043003-016	ATTACHMENT SCREW NC10*5/8" FLAT HEAD SS304
	AF804L		
	AF806L		
	AF808R		
	AF804X	4102043003-019	ATTACHMENT SCREW NC10*3/4" FLAT HEAD SS304
	AF806X		
	AF808L		
	AF810L		
	AF810R		
	AF810X		
	AF812R		
	AF814R		
	AF816R		
	AF816X		
AF818X			

IPB	Model	Catalog No	Description
9.6	AF804-18	4102043002-019	ATTACHMENT SCREW NC10*3/4" OVAL HEAD SS304
9.7	AF803L	5121610314	SUCTION NOZZLE AF803L
	AF804L	5121610312	SUCTION NOZZLE AF804L-8R
	AF806L		
	AF808R		
	AF804X	5121610313	SUCTION NOZZLE AF804X-10L
	AF806X		
	AF808L		
	AF810L		
	AF810R	5121610403	SUCTION NOZZLE AF810R-12R
	AF810X		
	AF812R	5121610404	SUCTION NOZZLE AF814R-16R
	AF814R		
	AF816R		
	AF816X	5121610405	SUCTION NOZZLE AF816X-18X
AF818X			
9.8	AF803L	5113610200	DIRT COLLECTOR 2" LOWER PLUG AF803L
	AF804L	5114610200	DIRT COLLECTOR 75 LOWER PLUG AF804L-8R
	AF806L		
	AF808R		
	AF804X	5116610200	DIRT COLLECTOR 76 LOWER PLUG AF804X-10L
	AF806X		
	AF808L		
	AF810L		
	AF810R	5115610200	DIRT COLLECTOR 3" LOWER PLUG AF810R-18
	AF810X		
	AF812R		
	AF814R		
	AF816R		
	AF816X		
AF818X			
10	AF803L	W5143610200-01	HYDRAULIC MOTOR PVC AF803
	AF804L	W5144610200-01	HYDRAULIC MOTOR PVC AF804L-8R
	AF806L		
	AF808R		
	AF804X	W5146320200-01	HYDRAULIC MOTOR SS304 AF804X-10L
	AF806X		
	AF808L		
	AF810L		
	AF810R	W5145320200-01	HYDRAULIC MOTOR SS304 AF810R
	AF810X	W5145320201-01	HYDRAULIC MOTOR SS304 AF810X-18
	AF812R		
	AF814R		
	AF816R		
	AF816X		
AF818X			

IPB	Model	Catalog No	Description
11	AF803L	W5173390000-01	DIRT COLLECTOR HEAD BEARING BRASS AF803
	AF804-18	W5173390001-01	DIRT COLLECTOR HEAD BEARING BRASS AF804-18
12	AF800	5293113007-029	STUD 5/16"NC*29 SS304
13	AF800	4112113901	NUT 5/16"NC BRASS
14	AF803L	E7160403000	HYD PISTON 40 SS304 AF803/9800
	AF804-18	E7160503000	HYD PISTON 50 SS304 AF800
14.1	AF800	4081056100-331	O-RING 331
15	AF800	E4510020003-07	COMP HYDRAULIC VALVE DOROT GALIL 09AN 2"BSP
16	AF803L-10L	E5412036301-01	SHORT DISTRIBUTOR DELRIN ASSM
	AF810R-18	E5412036302-01	DOUBLE DISTRIBUTOR DELRIN ASSM
16.1	AF800	4081034100-126	O-RING 126
16.2	AF810R-18	4470030300	DIAMOND VALVE DOROT 10 Bar 25-300 3/8"
17	AF800	CS11010015	PRESSURE GAUGE SET AF800/9800/500
18	AF800	4640314002	PLUG 1/4" PLASTIC
19	AF800	4640214082	MALE BRANCH T 8*1/4"*8 PLASTIC
20	AF800	4640618082	MALE ELBOW 1/8"*8 PLASTIC
21	AF800-DC	CSD1100112100	CONTROLLER 1-10 DC + 1 SOLENOID COMPLETE
	AF800-AC	CSA1100114100	CONTROLLER 1-10 AC + 1 SOLENOID COMPLETE
21.1	AF800-DC	4430010902	SOLENOID DCL GALSOL 2W
	AF800-AC	4430030901	SOLENOID AC GALSOL 24V
21.2	AF800-DC	4440211002	CONTROLLER 1-10 DC 2 PORTS + DP
	AF800-AC	4440311002	CONTROLLER 1-10 AC 2 PORTS + DP
21.2.1	AF800-DC	4450110200	EXPENSION CARD FOR 1-10 DC CONTROLLER
	AF800-AC	4450110300	EXPENSION CARD FOR 1-10 AC CONTROLLER

AF800-AC Control System

The symbol **KEY** , with letter inside, sign the connection port on the filter with accordance to the letter.

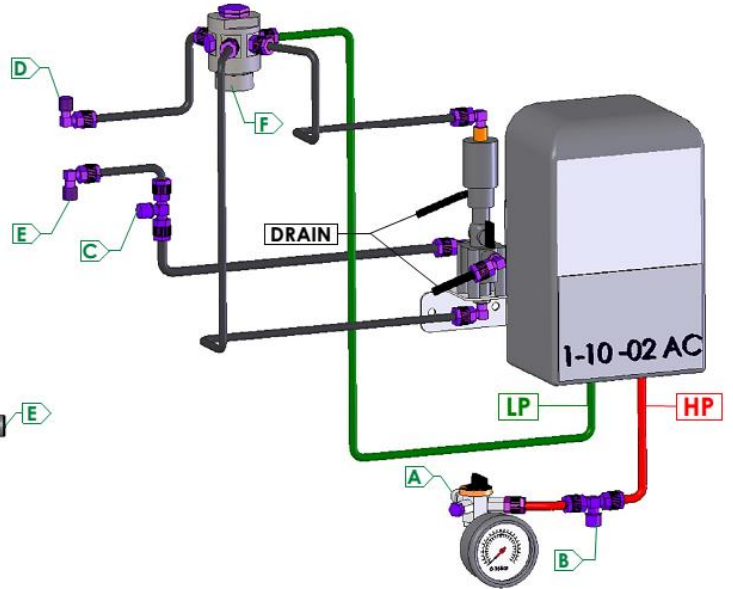
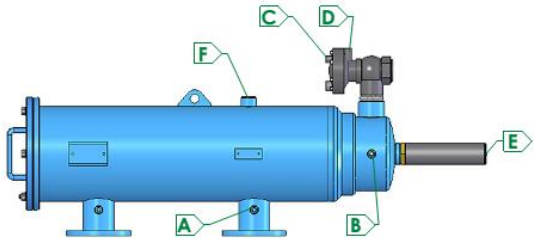

AF800-DC Control System

The symbol **KEY** , with letter inside, sign the connection port on the filter with accordance to the letter.

