

Rovatti Deep well pump, type 6V

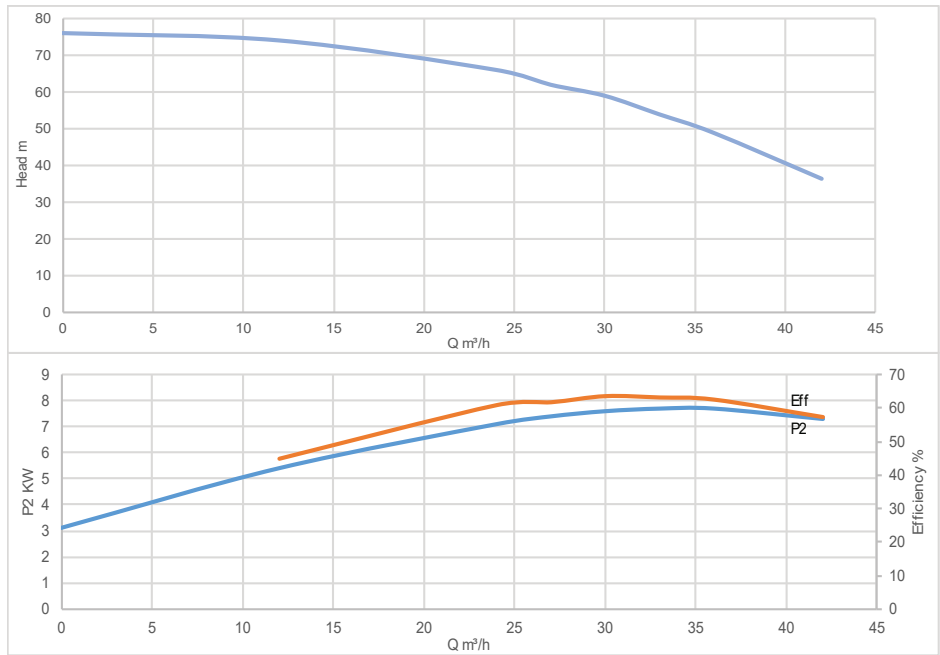

Performance Curve

Pump data

Pump Model	P2		Connections		Full Load Current (A)	Rated Voltage (V)
	HP	kW	Di-1	Di-2		
7024599			146	80		

Q (m³/h)	0	12	24	27	30	33	36	42
H (m)	76	74	66	62	59	54	49	36.5

Pump Diagram

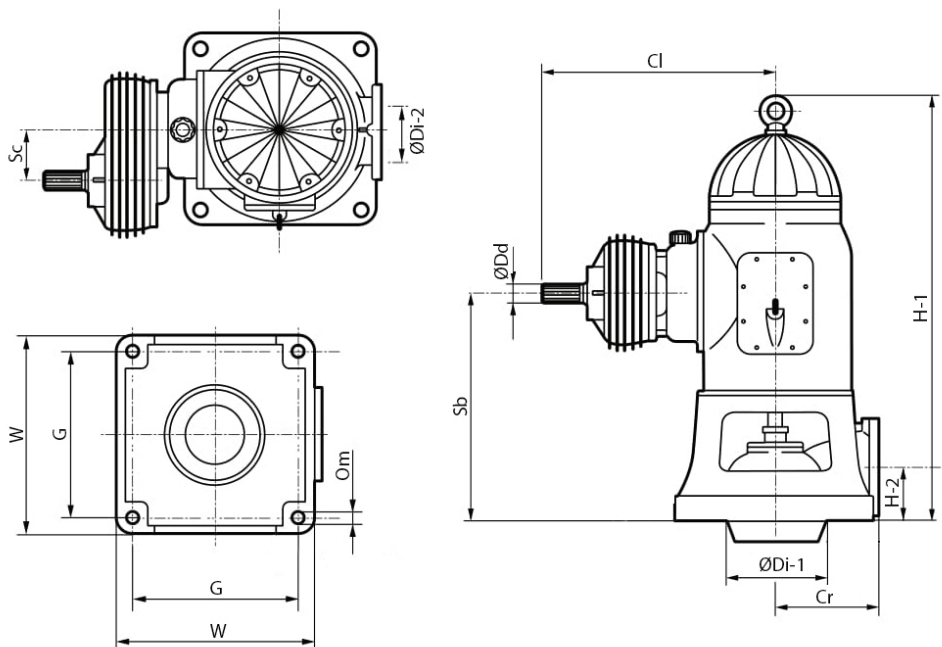

Model	W	G	Om	Cr	H-1	H-2	Cl	Sb	Sc	Di-1	Di-2	Dd
7024599	280	240	18	148	685	105	341	405	81	146	80	13/8"