

INTRODUCTION

The Rotary blades vacuum pumps Battioni Pagani® have been designed and constructed in compliance with EEC safety regulations and have been assessed for risks according to standard UNI EN ISO 12100:2010; in particular they are in conformity with directive 2006/42/CE and subsequent modifications and additions.

Since the design of this pump complies with the definition of a machine as contained in the Machinery Directive 2006/42/EC, the pump bears the CE mark on its identification plate. However, it must be pointed out that because of its application and the purpose for which it is supplied, which specifies that it be installed by the buyer (without motive power), Battioni Pagani® refuses any and all responsibility if the instructions in this operation and maintenance manual are not followed.

This manual contains the Declaration of CE conformity and all the instructions required by users, and by the manufacturers of plant systems, for using our products safely. As a result, the manual must always be kept near the rotary blades vacuum pump.



This danger symbol in the manual means that important safety instructions are given. This information is destined primarily for the operator whose responsibility it is not only to comply with them personally, but also to ensure compliance by other persons exposed to the connected risks.

The descriptions and illustrations in this manual are purely indicative.

The manufacturer reserves the right to make any type of change to this manual at any time.

GUARANTEE

At the moment of receiving the Rotary blades vacuum pump check that it is complete with all its parts.

Any anomalies or missing parts must be notified within 8 days of receipt of the product.

The Supplier guarantees that the product sold is free from defects and undertakes to repair or, by final decision, to replace the faulty parts only if the defects are clearly attributed to the manufacturing process or to the materials used. In any case the costs of labour, travel and transport, and any customs expenses shall be paid by the Purchaser. The vendor is not obliged to pay damages except in the case of fraud or grave offence. All parts subject to normal wear are excluded from the guarantee. The guarantee will cease to be valid if:

- the faults reported are the result of accidents or obvious carelessness or negligence on the part of the Purchaser,
- the parts have been modified, repaired or fitted by persons not authorised by the vendor,
- the failures and breakages have been caused by use that is unsuitable or heavier than that provided for by the vendor,
- the Purchaser has failed to make the payments as agreed by contract.

The Purchaser loses his/her right to the guarantee if he/she fails to report the defects to the vendor within 8 days of discovery, making an exception to article 1512 of the Italian Civil Code. The Vendor reserves the right to make changes or improvements to his/her products without being obliged to make the same changes or improvements to the units already produced and/or delivered previously. The Vendor is not responsible for accidents or for the effects of accidents to people or property due to defective materials and/or workmanship.

Thank you for choosing Battioni Pagani®.

Battioni Pagani®



OBLIGATORY SAFETY SIGNS TO BE DISPLAYED IN THE WORK PLACE AND IN THE VICINITY OF THE ROTARY BLADES VACUUM PUMP

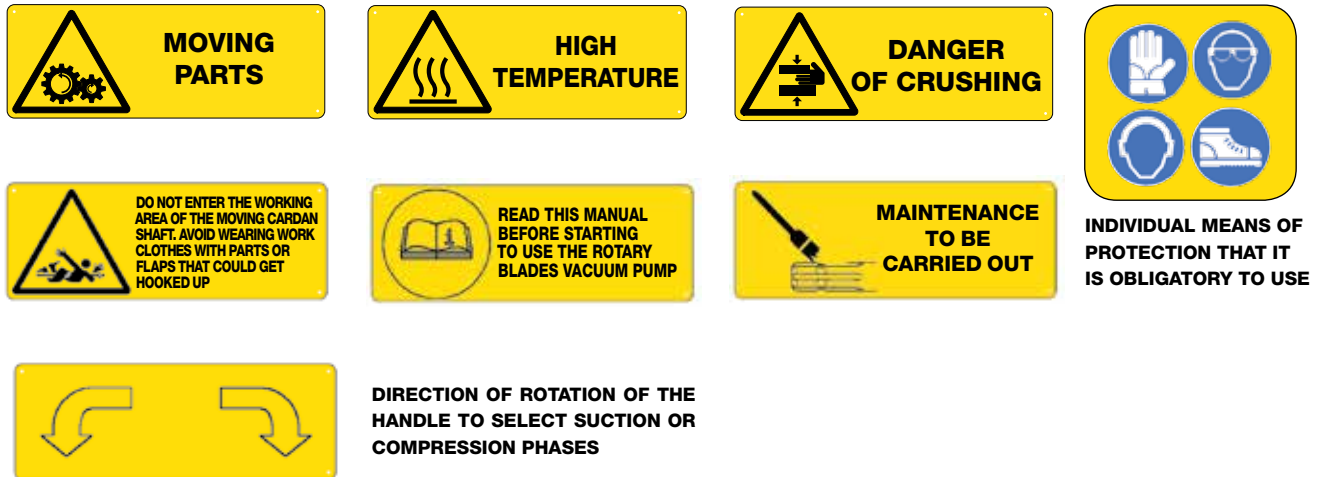

CONDITIONS AND LIMITS OF USE – LIST OF DANGERS

In the Common Market countries, the installation must comply with directive 2006/42/CE and subsequent modifications, while in the other countries it must comply with the safety regulations of the country.

This Rotary blades vacuum pump has been designed to create a vacuum or pressure inside a tank connected to it.



Under no circumstances must liquids, dust or any kind of solid matter enter the Rotary blades vacuum pump because they could cause it to break. Therefore it is necessary to equip the system with safety valves.

The use of the Rotary blades vacuum pump for any purpose other than that specified above is absolutely forbidden, not provided for by the manufacturer and therefore highly dangerous.

Do not use the Rotary blades vacuum pump to handle flammable and/or explosive liquids and materials or for materials that give off flammable gasses.

Read This Manual Before Using The Suction Unit/Compressor

Do not use the rotary blades vacuum pump in a potentially explosive atmosphere.

Never remove the guards fitted on the Rotary blades vacuum pump and always check their efficiency every time the machine is used.

Any work on the machine must be carried out while it is not running.

Failure to comply with the instructions given in this manual may lead to the following dangers:

- Danger of being crushed by the Rotary blades vacuum pump mass during handling and transport;
- Danger of getting entangled in the shaft transmission parts if the necessary guards are removed;
- Heat dangers due to the temperatures that can be reached by the Rotary blades vacuum pump;
- Acoustic danger due to the noise generated and to failure to use personal means of protection;
- Danger to operator's hands during testing with suction and delivery tubes detached from the pump;
- Danger of abrasion from the shaft of the hydraulic pump support if the Rotary blades vacuum pump is operated with the hydraulic pump removed;
- Danger of projection of fluid and solid materials owing to an heavy breakage of the Rotary blades vacuum pump.



SUMMARY

INTRODUCTION.....	30
GUARANTEE.....	30
OBLIGATORY SAFETY SIGNS TO BE DISPLAYED IN THE WORK PLACE AND IN THE VICINITY OF THE	
ROTARY BLADES VACUUM PUMP.....	31
CONDITIONS AND LIMITS OF USE – LIST OF DANGERS.....	31
SUMMARY	32
GENERAL INFORMATION	34
1 - VERSIONS OF THE ROTARY BLADES VACUUM PUMP	34
1.1 IDENTIFICATION LABEL	35
INSTRUCTIONS FOR USE AND MAINTENANCE.....	36
2 - PACKAGING, STORAGE, HANDLING AND TRANSPORT.....	36
2.1 PACKAGING	36
2.2 STORAGE	36
2.3 HANDLING AND TRANSPORT.....	36
3 - ASSEMBLY, FITTING, INSTALLATION, DISASSEMBLY, RE-FITTING.....	36
3.1 INSTALLATION DRAFT.....	36
3.2 DOUBLE OUTLET INSTALLATION DRAFT.....	37
3.2.1 DIAGRAM OF INSTALLATION WITHOUT MANIFOLD ON IRRIGATION MACHINES	9
3.3 ASSEMBLY AND FITTING - INSTALLATION	37
3.4 HYDRAULIC PLAN (/H VERSION)	38
3.5 INSTRUCTIONS FOR USE AND MAINTENANCE OF HYDRAULIC MOTOR	39
3.6 DISINSTALLATON.....	41
3.7 DISASSEMBLY	41
3.7.1 Back disassembly.....	41
3.7.2 Front disassembly.....	42
3.8 RE-FITTING – RE-INSTALLATION.....	42
3.8.1 Re-fitting of the back	42
3.8.2 Re-fitting of the manifold	43
3.8.3 Re-fitting of the front.....	44
3.8.4 Correct positioning of reversing gear	44
4 - DIRECTION OF ROTATION INVERSION	45
5 - START-UP	45
5.1 OPERATION WITHOUT OVER-PRESSURE VALVE (ONLY MEC SERIES).....	45
5.2 DIRECTION OF ROTATION.....	45



6 -	SET-UP OF THE LUBRICATION SYSTEM	46
6.1	NORMAL LUBRICATION.....	46
6.2	FORCED LUBRICATION.....	46
6.3	AUTOMATIC LUBRICATION	46
6.4	OIL TO USE.....	46
	6.4.1 Absolutely, do not use following oil brands	46
	6.4.2 Gearbox oil	47
6.5	OIL LEVEL.....	47
6.6	QUANTITY OF LUBRICATION OIL.....	48
6.7	REGULATION FOR LUBRICATING OIL	49
7 -	OVERPRESSURE AND VACUUM ADJUSTMENT VALVES.....	49
8 -	TESTING AND RUNNING IN	50
8.1	TESTING.....	50
8.2	RUNNING IN	50
9 -	START, OPERATION, STOP	51
9.1	START	51
9.2	OPERATION	51
9.3	STOP	52
9.4	CONTROLS	52
9.5	PROTECTIVE DEVICES.....	52
9.6	PROTECTIVE DEVICES.....	52
9.7	INDIVIDUAL MEANS OF PROTECTION TO BE USED	52
10 -	TROUBLESHOOTING	53
11 -	MAINTENANCE, INSPECTIONS AND CHECKS, REPAIRS, TECHNICAL ASSISTANCE.....	54
11.1	CLEANING	54
	11.1.1 Washing of the body.....	54
	11.1.2 Washing of oil tank	54
	11.1.3 Washing and cleaning of valves	54
11.2	CHECKING OF VALVES.....	54
11.3	INSPECTION AND REPLACEMENT OF Blades.....	54
	11.3.1 General information on blades	54
	11.3.2 Inspection of blades.....	55
	11.3.3 Replacement of blades	55
	11.3.4 Blades dimensions.....	56
11.4	REPLACEMENT OF RUBBER BALL.....	56
11.5	REPLACEMENT OF GEARS (VERSION / M - MA / K - KA).....	56
11.6	TECHNICAL ASSISTANCE	57
11.7	REGULAR SERVICING.....	57
12 -	PUTTING OUT OF SERVICE AND DEMOLITION	57
SPARE PARTS	254	
TECHNICAL DATA	305	

GENERAL INFORMATION

1 - VERSIONS OF THE ROTARY BLADES VACUUM PUMP

The Rotary blades vacuum pump can be supplied in the following versions:

SERIE	M	MA	P	D	H	K	KA	G	GA
MEC 1000/1600	O	-	O	-	-	-	-	-	-
MEC 2/3/4000	O	-	O	O	O	-	-	O	O
MEC 5/6.5/8000	O	-	O	O	O	-	-	O	O
MEC 9/11/13500	O	O	O	O	O	-	-	O	O
STAR 60-72-84	O	O	O	O	O	O	O	O	O
AGRI 60-72-84	O	O	O	O	O	O	O	O	O

- Not available O Available

.../ M VERSION--.../MA VERSION (with gearbox)

ANTICLOCK
WISE



- ... / **M** the power take-off is actuated through a cardan shaft at 540 r.p.m. This version can be recognised by the gearbox placed at the front of the Rotary blades vacuum pump and by the identification plate.
- ... / **MA** the power take-off is actuated through a cardan shaft at 1000 r.p.m. This version can be recognised by the gearbox placed at the front of the Rotary blades vacuum pump, by the identification plate and by the punching placed on the upper part of the gearbox.

.../ P VERSION (for pulley application)

CLOCK
WISE



ANTICLOCK
WISE
ON REQUEST

- ... / **P** the power take-off is actuated through a pulley and belts. This version can be recognised by the cylindrical shaft with key of the power take off and by the plate, .../P pulley application.

.../ D VERSION (direct drive)

ANTICLOCK
WISE



CLOCK WISE
ON REQUEST

- ... / **D** the power take-off is actuated through a cardan shaft directly connected to the splined hub. This version can be recognised by the splined hub placed at the front of the Rotary blades vacuum pump and by the identification plate, .../D direct drive

.../H VERSION (for hydraulic drive)

CLOCK
WISE



- ... / **H** the power take-off is actuated through a gears hydraulic motor. This version can be recognised by the hydraulic motor support placed at the front and by the identification plate, .../H hydraulic drive.



.../ K VERSION –.../KA VERSION (with gearbox and hydraulic pump support)

**ANTICLOCK
WISE**



- ... / K the power take-off is actuated through a cardan shaft at 540 rpm and is designed to actuate an hydraulic pump of group 2 or group 3. This version can be recognised by the hydraulic pump support and by the identification plate.
- ... / KA the power take-off is actuated through a cardan shaft at 1000 rpm and is designed to actuate an hydraulic pump of group 2 or group 3. This version can be recognised by the hydraulic pump support, by the identification plate and by the punching placed on the upper part of the gearbox.

Versions... /K and ... /KA have been designed so that they can be used to actuate the hydraulic accessories (gate valves, draft tube, support base etc.) on the tank car because in many cases the hydraulic pump on the tractor does not have sufficient oil flow rate for all the movements. With this application all the work may be carried out from the tractor cabin by operating only one distributor

.../ G VERSION –.../GA VERSION (application for GARDA or LEDRA)

**CLOCK
WISE**



- ... / G version of Rotary blades vacuum pump that is applied on the GARDA or the LEDRA group; it cannot be used on its own. This version can be recognised by the external pinion placed at the front of the Rotary blades vacuum pump and by the identification plate.
- ... / GA version of Rotary blades vacuum pump that is applied on the GARDA or the LEDRA group at 1000 rpm; it cannot be used on its own. This version can be recognised by the external pinion placed at the front of the Rotary blades vacuum pump and by the identification plate.

All the versions of the STAR and AGRI series of Rotary blades vacuum pump can be supplied with back tank in cast iron (versions /MV, /MAV, /PV, /DV, /HV, /KV /KAV) or with extractable side tank in sheet metal (versions /MF, /MAF, /PF, /DF, /HF, /KF, /KAF).

1.1 IDENTIFICATION LABEL

Every rotary blades pump is supplied with an identification label stating:

- rotary blades pump model
- serial number
- production year
- max relative pressure
- max vacuum
- max absorbed power
- max r.p.m.
- max rate of flow
- CE mark
- weight of pump



*Every identification plate is protected by a special sky-blue colour film, to remove after painting.
This film has been introduced to guarantee the tracing of the pump for warranty purposes.*

IDENTIFICATION LABEL WITH PROTECTIVE FILM FOR PAINTING



INSTRUCTIONS FOR USE AND MAINTENANCE

2.0 - PACKAGING, STORAGE, HANDLING AND TRANSPORT

2.1 PACKAGING

The Rotary blades vacuum pump are supplied without packaging. On request the following packaging can be used:

- wooden base and shrink-wrap;
- wooden cases and shrink-wrap for shipment by sea or air.

2.2 STORAGE

In order to preserve the Rotary blades vacuum pump correctly, it must be stored:

- under cover, sheltered from adverse weather conditions;
- resting horizontally on its four feet.

The Rotary blades vacuum pump are lubricated during testing at our factory with special oil that ensures lubrication of the various internal components for approx. 6 months.

In the event of subsequent storage it is advisable to wash the inside of the body with oil and diesel oil (as stated on this manual).

2.3 HANDLING AND TRANSPORT

Mass of Rotary blades vacuum pump: (see technical sheet).



The Rotary blades vacuum pump should be:

- *Harnessed by means of metal hooks inserted in the hole for gripping, or a sling;*
- *Lifted with a hoisting truck (if on pallet), bridge crane, or crane.*
- *MEC 1000/1600 pumps must be lifted through a 1/4" gas eyebolt that has to be fitted instead of drain cock.*

The Rotary blades vacuum pump is supplied with a guard that is in compliance with EC directives. This guard should be fitted on by the fitter using the four screws supplied.

3.0 - ASSEMBLY, FITTING, INSTALLATION, DISASSEMBLY, RE-FITTING

The procedures concerning Rotary blades vacuum pump versions .../G and .../GA are given in the GARDA/LEDRA group instructions.



When carrying out maintenance operations, inspections, checks and repairs you are advised to wear the individual means of protection listed in this manual.



All maintenance operations, inspections, checks and repairs should be carried out with the greatest care and with the tractor not running and the power take-off disconnected.



It is essential to prevent sewage from entering the Rotary blades vacuum pumps. The entrance of sewage would cause the blades and consequently the rotor to break.

It is therefore necessary to equip the system with an overflow valve, "3", and a safety overflow valve, "2", between the Rotary blades vacuum pump and the tank car (see Figure 1)

3.1 INSTALLATION DRAFT



- 1 - Pump
- 2 - Secondary shut-off valve
- 3 - Primary shut-off valve
- 4 - Silencer
- 5 - Motorized joint
- 6 - Swivel joint
- 7 - Stemgate
- 8 - Overpressure valve
- 9 - Depression valve

Figure 1



3.2 DOUBLE OUTLET INSTALLATION DRAFT

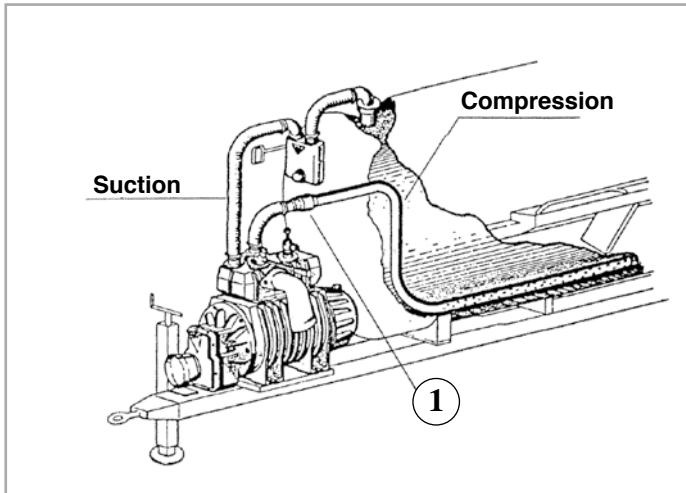

The Rotary blades vacuum pump can be used as a mixer by fitting, on request, a double outlet on the manifold (see Figure 2). In this case there will be the intake of a normal Rotary blades vacuum pump, but a perforated tube placed inside the tank car must be used for the compression. When the handle is positioned on the compression phase, the air will be forced out through the holes in the tube so causing mixing of the previously loaded sewage (never exceed the maximum working absolute pressure of 2,5 bar) equal to 1,5 relative bar.

Figure 2



With this system, a check valve (1) must be fitted on the delivery tube to prevent the transfer of sewage inside the Rotary blades vacuum pump.

3.2.1 DIAGRAM OF INSTALLATION WITHOUT MANIFOLD ON IRRIGATION MACHINES

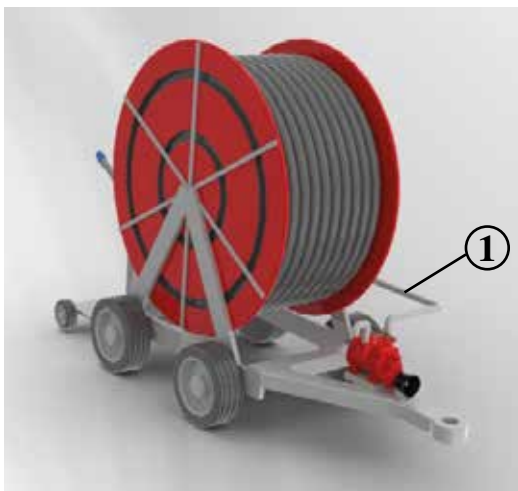

Battioni Pagani® produces a complete line of rotary blades vacuum pumps for use on irrigation machines.

To use the rotary pump correctly, the irrigation machine must be completely filled with water and must not be partially empty.

Important: never exceed the relative maximum operating pressure of 3.5 bar.



With this system, the delivery pipe must be equipped with a check valve (1) to prevent water from backing up into the rotary blades vacuum pump.

3.3 ASSEMBLY AND FITTING - INSTALLATION

The Rotary blades vacuum pump should be assembled and installed using the following procedure:

- 1) Assemble the Rotary blades vacuum pump horizontally with its feet facing downwards. The assembly position on the vehicle should be easy to access and be protected. A 5° maximum longitudinal slope of the Rotary blades vacuum pump with respect to the horizontal plane must not be exceeded.
 - 2) Bolt the Rotary blades vacuum pump using screws and nuts passing through the specially provided slots or holes in the feet;
- 3-M/K)** To install the .../M-K version Rotary blades vacuum pump, connect the cardan shaft at 540 r.p.m. of the tractor to the P.T.O. shaft of the Rotary blades vacuum pump.
- 3-MA/KA)** To install the .../MA-KA version Rotary blades vacuum pump, connect the cardan shaft at 1000 r.p.m. of the tractor to the P.T.O. shaft of the Rotary blades vacuum pump.



Don't exceed the maximum slope allowed for the cardan shaft.

3-P) To install the .../P version Rotary blades vacuum pump, attach a driven pulley to the shaft and fix it with the special screw located on the front of the shaft. The driven pulley may be fitted directly on the cylindrical shaft if the radial load is brought close to the bearing. Never transfer axial loads. Then connect the driven pulley to the driving pulley with the correct length of driving belts. The number and type of belts must be calculated according to the power to be transferred to the Rotary blades vacuum pump. When this operation has been completed, the necessary guard must be installed to isolate the driving parts (pulleys and belts) and prevent access to them by the operators.

- The best tension is the lower one where the belt doesn't slide under max loading condition
- Check frequently the tension during first 24/48 hours of running phase
- The over-tension reduces the life of belt and bearing
- Keep belts free from any material which may cause sliding
- Check periodically the transmission. Set it when sliding

To check the tension on a normal transmission, do what follows:

- measure the length of free stretch (t)
 - In the middle of free stretch of the belt (t) apply a force(perpendicular to free stretch) nought to bend the belt 1.6 mm per 100 mm in length of the free. For example, the decline of a free stretch of 1000 mm is 16 mm.
 - Compare the force you have applied and measured through a instrument with datas stated under our table. If the force is included between "minimum force" datas, it means that the belt is not enough stretched.
- If the force exceeds "max force" datas, it means that the belt is too stretched.

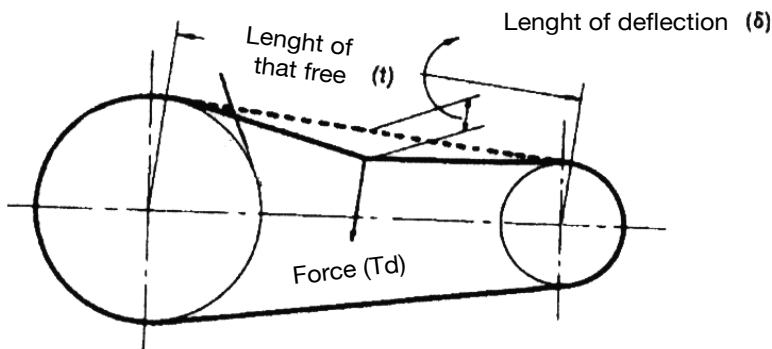

Section	Force	
	Min	Max
	Kg.	Kg.
A	0,68	1,02
B	1,58	2,38
C	2,93	4,75
D	5,77	8,61
E	9,60	14,30

3-D) To install the .../D version Rotary blades vacuum pump, connect the cardan shaft at 1000 rpm of the tractor to the P.T.O. shaft of the Rotary blades vacuum pump.



Don't exceed the maximum slope allowed for the cardan shaft.

3-H) To install the .../H version Rotary blades vacuum pump, attach an hydraulic motor (flanging European unification - Group 3,5 for MEC 2000-3000-4000-5000-6500-8000 series and Group 4 for STAR, AGRI and MEC 9000-11000-13500 series) to the power take-off shaft and fix it, using special screws, to the cast iron support located at the front.

3.4 HYDRAULIC DRAFT (/H version)

The hydraulic system required for the operation of Rotary blades vacuum pump .../H is schematized in Figure 3 and the technical characteristics of the hydraulic motor are shown in Table 2.

The splining of the hydraulic motor is of a type DIN 5482 - Z=23 for MEC 9000-11000-13500, STAR, and AGRI series and of type DIN 5482 - Z=20 for MEC 2000-3000-4000-5000-6500-8000 series.

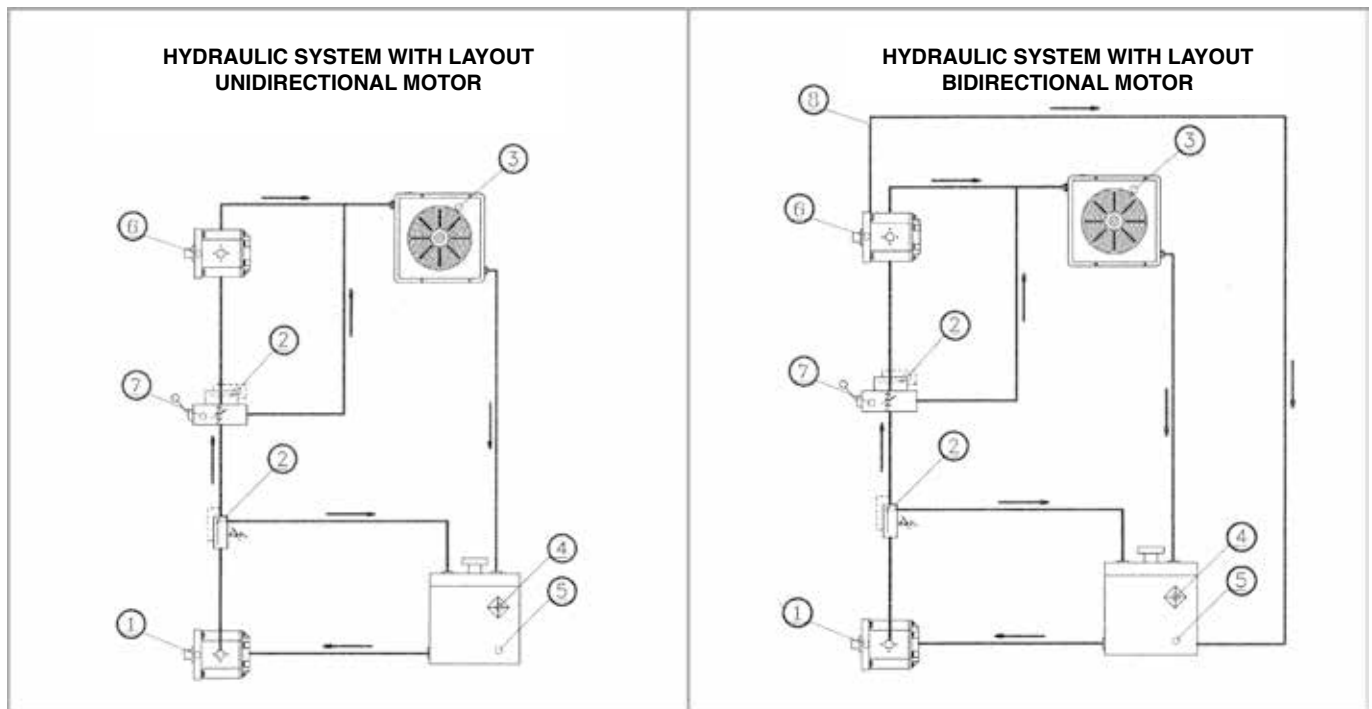

- 1 Hydraulic pump
- 2 Over-pressure valve
- 3 Radiator
- 4 Oil filter

- 5 Oil tank
- 6 Hydraulic motor
- 7 Distributor
- 8 Drainage

4) Then connect the intake/compression pipe of the tank car to the Rotary blades vacuum pump tightening it to the adjustable elbow using metal clamping bands in relation to the diameter of the pipe.

3.5 HYDRAULIC MOTOR INSTALLATION INSTRUCTION

Make sure take the rotation of the unidirectional motor is the proper are for your system. Make sure take this is a good linear matching between motor shift and power take off.

TANK. Tank capacity must be sufficient for the system's operating conditions (~ 3 times the amount of oil in circulation) to avoid overheating of the fluid. A heat exchanger should be installed if necessary. The intake and return lines in the tank must be spaced apart (by inserting a vertical divider) to prevent the return-line oil from being taken up again immediately.

LINES. The lines must have a major diameter which is at least as large as the diameter of motor or pump ports, and must be perfectly sealed. To reduce loss of load, the lines should be as short as possible, reducing the sources of hydraulic resistance (elbow, throttling, gate valves, etc.) to a minimum. A length of flexible tubing is recommended to reduce the transmission of vibrations. All return lines must end below the minimum oil level, to prevent foaming. Before connecting the lines, remove any plugs and make sure that the lines are perfectly clean.

FILTERS. We recommend filtering the entire system flow rate. Filters should be fitted as indicated in the first pages of the catalogue. Only coarse filters are recommended for pump intake.

HYDRAULIC FLUID. Use hydraulic fluid conforming to ISO/DIN standards, having viscosity as specified in the first pages of the catalogue. Avoid using mixtures of different oils which could result in decomposition and reduction of the oil's lubricating power.

ENGLISH

DRAIN HOLE: on bi-directional motors with drain hole, the hole has to be connected to the oil tank through an hose of at least 22 mm of diameter. To avoid the forming of foam inside the tank, the hose has to be connected under the minimum level.

STARTING UP. Check that all circuit connections are exact and that the entire system is completely clean. Insert the oil in the tank, using a filter. Bleed the circuit to assist in filling. Set the pressure relief valves to the lowest possible setting. Turn on the system for a few moments at minimum speed, then bleed the circuit again and check the level of oil in the tank. If the difference between pump or motor temperature and fluid temperature exceeds 10 °C, rapidly switch the system on and off to heat it up gradually. Then gradually increase the pressure and speed of rotation until the pre-set operating levels as specified in the catalogue are attained.

PERIODICAL CHECKS – MAINTENANCE Keep the outside surface clean especially in the area of the drive shaft seal. In fact, abrasive powder can accelerate wear on the seal and cause leakage. Replace filters regularly to keep the fluid clean. The oil level must be checked and replaced periodically depending on the system's operating conditions.

RESOLUTION PROBLEMS:

- Circuit is open. Downstream of the engine you have the oil reservoir and not the pump. If the engine remained in rotation with the engine off, there will be overpressure, but cavitation. To solve this problem it would take a one-way valve that lets the oil or some of it through calibration, the engine sent to his desire to avoid that the engine air pump.

- Circuit is closed. You could have an overpressure. To solve the problem or put an overpressure valve, as recommended in the key facility attached or a calibrated one-way valve that bypasses the engine. Compared to the first case, the last option is cheaper and less invasive on a system already exists as it does not require an additional hole in the tank.

HYDRAULIC MOTOR								
Hydraulic Motor	Rotary blades vacuum Pump	Max pressure of exercise	Flow rate	Rpm	Pressure	Max pressure Hydraulic system	Trasmitted Power	Torque
KM 30.51-SO	MEC 2000/H	1,5 bar	74,8 l/min	1 4 0 0	78 bar	230 bar	8 kW	57 Nm
	MEC 3000/H				107 bar		11 kW	78 Nm
	MEC 4000/H				136 bar		14 kW	99 Nm
	MEC 5000/H				165 bar		17 kW	120 Nm
	MEC 6500/H				204 bar		21 kW	148 Nm
	MEC 8000/H				218 bar		22,5 kW	158 Nm
KM 40.87-SO	MEC 9000	1,5 bar	125 l/min	1 4 0 0	174 bar	280 bar	30 kW	211 Nm
	MEC 11000				186 bar		32 kW	226 Nm
	MEC 13500				198 bar		34 kW	240 Nm
KM 40.87-SO	AGRI/STAR 60/H	1,5 bar	107 l/min	1 2 0 0	197 bar	280 bar	29 kW	239 Nm
	AGRI/STAR 72/H				210 bar		31 kW	255 Nm
	AGRI/STAR 84/H				258 bar		38 kW	312 Nm

Table 1



3.6 DISINSTALLATON

The Rotary blades vacuum pump should be disinstalled using the following procedure:

.../M-K	.../P	.../D	.../H
1) Stop the power take-off of the tractor;	1) Stop the power take-off of the tractor;	1) Stop the power take-off of the tractor;	1) Stop the hydraulic system;
2) Remove the cardan shaft from the power take-off of the rotary blades vacuum pump;	2) Remove the driving belts.	2) Remove the cardan shaft from the power take-off of the rotary blades vacuum pump.	2) Remove the hydraulic connections to the motor.
3) Remove the connecting pipe that joins the rotary blades vacuum pump to the tank car, by loosening the metal band and sliding the pipe from the adjustable elbow;	3) remove the pipe that connects the rotary blades vacuum pump to the tank car. To accomplish this, loosen the metal clamp and pull the pipe out of the elbow;	3) remove the pipe that connects the rotary blades vacuum pump to the tank car. To accomplish this, loosen the metal clamp and pull the pipe out of the elbow;	3) remove the pipe that connects the rotary blades vacuum pump to the tank car. To accomplish this, loosen the metal clamp and pull the pipe out of the elbow;
4) Remove any hydraulic connections;	4) remove any plumbing connections;	4) remove any plumbing connections;	4) remove any plumbing connections;
5) Remove the clamping screws and disinstall the rotary blades vacuum pump.	5) remove the mounting screws and remove the rotary blades vacuum pump.	5) remove the mounting screws and remove the rotary blades vacuum pump.	5) remove the mounting screws and remove the rotary blades vacuum pump.

ENGLISH

3.7 DISASSEMBLY

3.7.1 Back disassembly

SERIE MEC 1000-1600-2000-3000-4000-5000-6500-8000

- 1) Remove the back cover or the lubrication pump (together with the connector joint) from the flange;
- 2) Remove the screws from the back flange;
- 3) Use two screws for screwing into the threaded extraction holes until the flange is removed;

SERIE MEC 9000-11000-13500

- 1) Remove the rear cover or oil pump (together with the connecting joint) from the flange;
- 2) Remove the seeger ring from the rear pin;
- 3) Remove the screws from the rear flange.
- 4) Screw two screws into the threaded extraction holes just until the flange can be removed;

STAR - AGRI /V (with rear cast iron oil tank)

STAR - AGRI /F (with rear flange and extractable side sheet oil tank)

- | | |
|---|---|
| <ol style="list-style-type: none"> 1. Remove the tank cover and the lubrication pump (together with the connector joint) from the back tank; 2. Remove the screws from the back tank; 3. Use two screws for screwing into the threaded extraction holes until the tank is removed; | <ol style="list-style-type: none"> 1. Close the oil cock placet on the tank 2. Remove the back cover with the lubrication pump (together with the connector joint) from the flange; 3. Remove the screws from the back flange; 4. Use two screws for screwing into the threaded extraction holes until the flange is removed; |
|---|---|



3.7.2 Front disassembly

.../M-K	.../P	MEC 9000-11000-13500.../P	.../D	.../H
1) Unscrew the screws of the gearbox cover;	1) Remove the driven pulley and the key;	1) Remove the driven pulley and the key;	1) Remove the flange with splined shaft;	1) Disassemble the hydraulic motor from its support;
2) Use two screws for screwing into the threaded extraction holes until the cover is removed;	2) Disassemble the front cover from the flange;	2) Remove the front cover from the flange;	2) Remove the sleeve with transmission flange and key	2) Remove the hydraulic motor support;
3) Remove the gear with splined shaft using an extractor if necessary;	3) Remove the screws from the front flange;	3) Remove the seeger ring from the front pin;	3) Remove the seeger ring placed in front of the bearing;	3) Remove the clamping screw located inside the sleeve and then slide the sleeve out;
4) For the pinion: unscrew the self-locking nut, use an extractor;	4) Slide the rotor from the body;	4) Remove the screws from the front flange.	4) Remove the clamping screw from the splined hub;	4) Remove the screws from the front flange;
5) Remove the seeger ring placed in front of the bearing	5) Remove the seeger ring placed in front of the bearing;	5) Pull the rotor out from the body;	5) Disassemble the rotor from the gearbox through a press	5) Slide the rotor from the body;
6) Slide the rotor from the body together with the gearbox;	6) Disassemble the rotor from the gearbox through a press;	6) Use a press to remove the rotor from the flange.		6) Remove the seeger ring placed in front of the bearing;
7) Disassemble the rotor from the gearbox through a press;				7) Disassemble the rotor from the gearbox through a press;

3.8 RE-FITTING – RE-INSTALLATION



IMPORTANT: Before proceeding with any re-fitting, replace the gaskets of the opened parts.

3.8.1 Re-fitting of the back

SERIE MEC 1000-1600-2000-3000-4000-5000-6500-8000

- 1) Remove the bearing and the spacer from the back flange;
- 2) Replace the flange gasket;
- 3) Bring the back flange up to the pump body, aligning it with the clamping holes;
- 4) Insert the 6 clamping screws in the holes and tighten them;
- 5) Fit the bearing on the flange using a drift;
- 6) Insert the spacer;
- 7) Re-fit the back cover or the lubrication pump (together with the connector joint) on the flange.



SERIE MEC 9000-11000-13500

- 1) Remove the bearing from the rear flange;
- 2) Insert the two centering pins into the pump body;
- 3) Replace the seal on the flange;
- 4) While lining up the holes with the two pins, bring the rear flange and the pump body together;
- 5) Insert the 6 mounting screws into the slotted holes and tighten to $45 \div 55$ Nm;
- 6) Using a mallet, install the bearing on the flange;
- 7) Install the seeger ring on the rear pin;
- 8) Install the rear cover or oil pump (together with the connecting joint) back onto the flange;
- 9) Remove the centering pins.



Figure A

ENGLISH

The MEC 9000/11000/13500 pump is equipped with a system that allows the flange to slide, which prevents breakage if foreign bodies become lodged between the rotor and the pump body. (Except for version G-GA)

To benefit from this system, it is important to follow these instructions:

Before starting the pump, make sure the rotor has not dropped down accidentally. This can be accomplished by making sure the cut in the flange lines up with the cut machined into pump body (see figure A).

STAR-AGRI /V (with rear cast iron tank)	STAR-AGRI /F (with later tank)
1. Remove the bearing from the back tank;	1. Remove the bearing from the back flange;
2. Replace the pump body gasket;	2. Replace the pump body gasket;
3. Bring the back tank up to the pump body, aligning it with the clamping holes;	3. Bring the back flange up to the pump body, aligning it with the clamping holes;
4. Insert the clamping screws in the holes and tighten them;	4. Insert the clamping screws in the holes and tighten them;
5. Fit the bearing on the tank using a drift;	5. Fit the bearing on the flange using a drift;
6. Put back the tank cover and the lubrication pump (together with the connector joint) on the back tank;	6. Put back the back cover and the lubrication pump (together with the connector joint) on the back flange;
7. Fill up the oil tank with oil for lubrication;	7. Open the cock placed on the side tank

3.8.2 Re-fitting of MEC 1000-1600-2000-3000-4000-5000-6500-8000 /STAR/AGRI manifold

1. Replace the manifold gasket;
2. Position the manifold on the pump body;
3. Tighten the clamping screws of the manifold.
4. Fit the reversing gear;
5. Fit the spring onto the reversing gear;
6. Replace the gasket onto the cover with sleeve;
7. Place the cover with sleeve onto the manifold;
8. Tight the fixing screws of the cover;
9. Assemble the handle.

Reinstalling MEC 9000-11000-13500 manifold

- 1) Replace the gasket on the manifold;
- 2) Position the manifold on the pump body;
- 3) Tighten the mounting screws on the manifold;
- 4) Install the reverse gear;
- 5) Install the spring on the reverse gear;
- 6) Install the spacer onto the spring on the reverse gear;
- 7) Replace the gasket on the manifold cover;
- 8) Position the manifold cover on the manifold;
- 9) Tighten the mounting screws on the manifold cover;
- 10) Install the oil seal into its seat on the manifold cover;
- 11) Install the handle and tighten it using the screw provided;



3.8.3 Re-fitting of the front

.../M-MA-K-KA	.../P	.../D	.../H
1) Mec 5000-6500-8000-9000-11000-13500: remove the seeger;	1) Remove the seeger;	1) Remove the seeger;	1) Remove the seeger;
1) Star/Agri: disassemble no. 3 screws;	2) Remove the bearing;	2) Remove the bearing;	2) Remove the bearing;
2) Disassemble the bearing;	3) Disassemble bearing and seeger rign;	3) Disassemble bearing and seeger rign;	3) Disassemble bearing and seeger rign;
3) Replace the flange gasket;	4) Mec 9000-11000-13500: insert the pins (supplied with the unit) into the pump body;	4) Mec 9000-11000-13500: insert the pins (supplied with the unit) into the pump body;	4) Mec 9000-11000-13500: insert the pins (supplied with the unit) into the pump body;
4) Mec 9000-11000-13500: install the pins (supplied with the unit) into the pump body;	5) Replace the flange gasket;	5) Replace the flange gasket;	5) Replace the flange gasket;
5) Fix the gearbox to pump body trough screws	5) Mec 9000-11000-13500: mount the front flange on the pump body using screws tightened to 45 ÷ 55 Nm;	5) Mec 9000-11000-13500: mount the front flange on the pump body using screws tightened to 45 ÷ 55 Nm;	5) Mec 9000-11000-13500: mount the front flange on the pump body using screws tightened to 45 ÷ 55 Nm;
5) Mec 9000-11000-13500: mount the gearbox on the pump body using screws tightened to 45 ÷ 55 Nm;	6) Using a buffer, install the bearing onto the flange and install the seeger;	6) Using a buffer, install the bearing onto the flange and install the seeger;	6) Using a buffer, install the bearing onto the flange and install the seeger;
6) Using a buffer, install the bearing onto the flange and install the seeger;	6) Mec 9000-11000-13500: using a buffer, install the bearing onto the flange, install the compensation ring and install the seeger;	6) Mec 9000-11000-13500: using a buffer, install the bearing onto the flange, install the compensation ring and install the seeger;	6) Mec 9000-11000-13500: using a buffer, install the bearing onto the flange, install the compensation ring and install the seeger;
6) Mec 9000-11000-13500: using a buffer, install the bearing onto the flange, install the compensation ring and install the seeger;	7) Put the front cover back on the flange.	7) Put the front cover back on the flange.	7) Put the transmission sleeve back on the rotor pin;
7) Mec 9000-11000-13500: install the spacer and mount the pinion on the shaft;	8) Mec 9000-11000-13500: remove the centring pins from the pump body.	8) Re-fit the splined hub;	8) Re-fit the hydraulic motor support;
7) Assemble the pinion onto the shaft;		9) Mec 9000-11000-13500: remove the centring pins from the pump body.	9) Mec 9000-11000-13500: remove the centring pins from the pump body.
8) Fit the self-locking nut for fixing the pinion;			
9) Insert the gear in the bearing housing;			
10) Fit the gearbox cover;			
11) Fill up the gearbox with oil			
12) Mec 9000-11000-13500: remove the centring pins from the pump body.			



The MEC 9000/11000/13500 pump is equipped with a system that allows the flange to slide, which prevents breakage if foreign bodies become lodged between the rotor and the pump body. (Except for version G-GA)

To benefit from this system, it is important to follow these instructions:

Before starting the pump, make sure the rotor has not dropped down accidentally. This can be accomplished by making sure the cut machined into flange lines up with the cut machined into pump body.



Flange slot



Cut for aligning flange with pump body



3.8.4 CORRECT POSITIONING OF REVERSING GEAR

To position the reversing gear correctly, follow the procedure below:

1. remove the handle (MEC series) or the reversing selector;
2. remove the manifold cover;
3. check that the flat part of the reversing gear is positioned at 45° to the power take-off;
4. re-fit the manifold cover and the handle (MEC series) or the reversing selector.

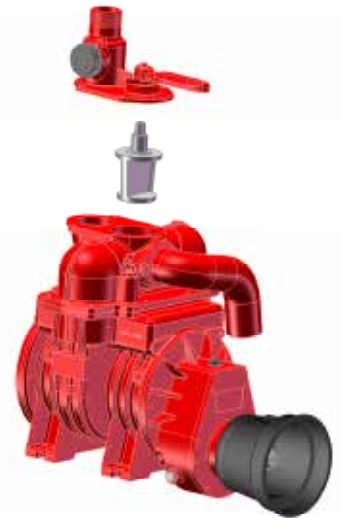

ENGLISH

4 - REVERSION OF DIRECTION OF ROTATION – ROTARY BLADES VACUUM PUMP WITH FORCE FEED OR AUTOMATIC LUBRICATION

If it is necessary to reverse the direction of rotation of a rotary blades vacuum pump with automatic lubrication, proceed as follows:

- disassemble the back cover and the automatic lubrication pump DX or SX (together with the coupling joint) from the flange;
- remove the screws from the back flange;
- use two screws in the threaded extraction holes until the flange is removed;
- remove the screws from the front flange;
- extract the rotor from the body together with the front flange;
- rotate the body together with the manifold 180° on a horizontal level;
- replace two flange gaskets;
- slide the rotor in the body together with the front flange;
- tighten the six securing screws of the front flange to the body;
- disassemble the bearing and the seeger from the back flange;
- approach the back flange to the pump body, positioning it on a level with the securing holes;
- insert the six securing screws in the holes and tighten;
- assemble the bearing on the flange by means of a stopper and fit the seeger;
- insert the spacer;
- re-assemble the back cover and replace the automatic lubrication pump DX or SX with another one with opposite direction of rotation (together with the coupling joint) to the flange.

In case of a rotary blades pump (**STAR** or **AGRI**) series with force feed lubrication, please follow the same instructions for pumps with automatic lubrication; while for rotary blades pump (**MEC**) series with force feed lubrication it is not necessary to replace the lubrication pump as it is bi-directional.

5 - START-UP

5.1 WORKING/RUNNING WITHOUT OVERPRESSURE VALVE – MEC SERIES



Before starting the rotary blades vacuum pump make sure that the hole in the manifold cover made for the overpressure valve is closed with a cap, if the overpressure and depression valves are present and working in the installation. If overpressure and depression valves are not fitted on their hole onto the rotary blades pump, close the hole by means of a cap.

5.2 DIRECTION OF ROTATION



Before starting the Rotary blades vacuum pump make sure that the P.T.O. shaft turns freely and that the direction of rotation is the same as the one indicated by the arrow.

Never turn the rotary blades vacuum pump in the direction of rotation opposite to the one for which it has been prepared (indicated by the arrow) as this could damage some components as well as prevent the operation of the pump.

6 - SET-UP OF THE LUBRIFICATION SYSTEM

Three different types of lubrication have been developed for the Rotary blades vacuum pump (see Figure 3).

6.1 NORMAL LUBRICATION

Lubrication occurs during the intake phase only. The vacuum created in the Rotary blades vacuum pump sucks oil from the tank. In the compression phase lubrication occurs with the residue of oil from the preceding phase. Normal lubrication is available only for models MEC 1000 and MEC 1600 that are manufactured with only this type of lubrication.

6.2 FORCED LUBRICATION

Lubrication occurs in both the intake phase and the compression phase through a gear pump placed at the back and actuated by the rotor shaft. The gear pump sucks oil from the tank and sends it to the manually adjusted metering tap. Excess oil returns to the tank through a tube connecting the tap to the tank. Forced lubrication is available as standard feature on models MEC, STAR, AGRI.

6.3 AUTOMATIC LUBRICATION

With this system lubrication occurs in both the intake phase and the compression phase by means of a piston metering pump with adjustable flow rate placed at the back and actuated by the rotor. The oil is injected directly into the Rotary blades vacuum pump, eliminating manual adjustment and saving a considerable amount of oil. Automatic lubrication is supplied, on request, on models MEC, STAR, AGRI.

Figure 3

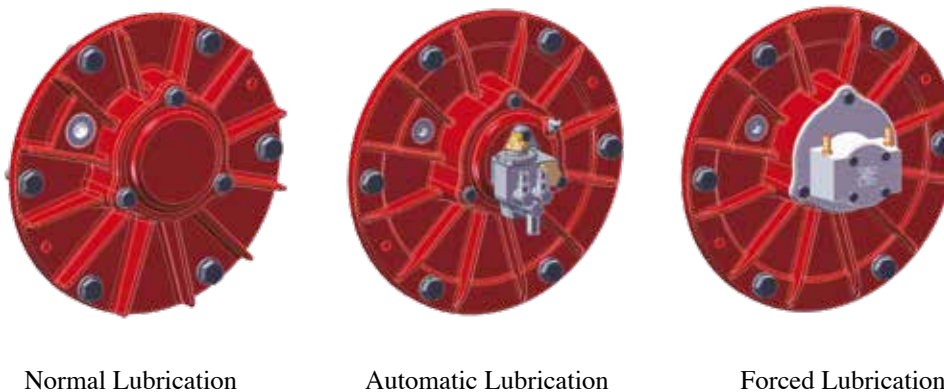

6.4 OIL TO USE

The Rotary blades vacuum pump are supplied without lubrication oil in the oil tank. BPP suggest to use “Battioni Pagani vacuum pump oil” for internal lubrication. It grants.

- Excellent resistance to oxidation
- Strong anti-rust property
- Excellent anti foam power
- Working temperature from -5 °C to 160 °C

IF “VACUUM PUMP OIL” IS NOT AVAILABLE, USE ONLY NEW MINERAL OIL MEETING ISO VG 100 (SAE 30)



6.4.1 ABSOLUTELY DO NOT USE FOLLOWING OIL TYPES:





TRANSMISSION OIL - USED OIL - HYDRAULIC OIL - VEGETABLE OIL - OIL FOR GEARS - OIL FOR BRANKES

YOU MUST USE ONLY NEW OIL

6.4.2 GEARBOX OIL

All M-MA-K-KA versions (with gearbox) are equipped with oil into the gearbox.
If you have to change the oil use only ISO VG 460.

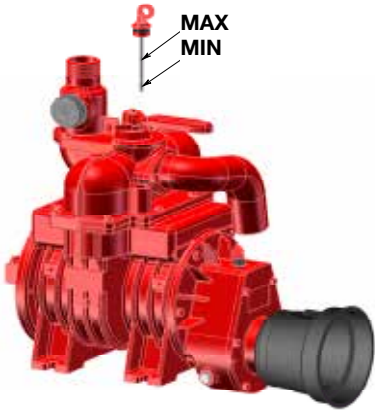
6.5 OIL LEVEL

MEC SERIES	STAR/V, AGRI/V SERIES	STAR/F, AGRI/F SERIES
 <p>Figure 4</p>	 <p>Figure 5</p>	 <p>Figure 6</p>

SERIE MEC

For internal lubrication, the minimum oil level is indicated by the notch at the lower end of the level rod (see Figure 4) located on the manifold and consequently the maximum level will be reached when the tank is full.

SERIE STAR/V, AGRI/V

For internal lubrication, the minimum oil level is indicated by the total length of the plug with level rod (see Figure 5) situated in the back tank and the maximum level will be reached with a full tank.

Serie STAR/F, AGRI/F

For internal lubrication, the minimum oil level is indicated by the lower notch on the indicator placed at the side of the external tank (see Figure 6) and the maximum level will be reached with a full tank

OIL TANK CAPACITY [L]							
MEC 1000	MEC 1600	MEC 2000	MEC 3000	MEC 4000	MEC 5000	MEC 6500	MEC 8000
0,6	0,7	1,0	1,2	1,5	2,5	3,1	3,8
MEC 9000	MEC 11000	MEC 13500	STAR/AGRI			STAR-AGRI/F	
2,5	3	3,5	3,7			4,3	

Table 2

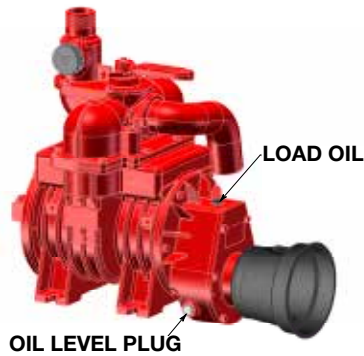

M – MA – K – KA VERSIONS: the gearbox has an oil loading plug at the top of the gearbox and an oil level plug (see Figure 7), placed on the side of the gearbox to allow the level to be checked

To ensure correct lubrication, the oil should always be visible in the oil level.

Figure 7

6.6 QUANTITY OF LUBRICATION OIL

When the Rotary blades vacuum pump is running, check that the quantity of oil indicated in Table 4 is dripping from the special regulator tap. These quantities are valid for both Forced and Automatic Lubrication. When necessary, add only unused clean oil to the tank.

/M – MA – K – KA VERSIONS: make the first oil change in the gearbox after approx. 100 working hours and subsequent changes approx. every 300 working hours.

MODEL	Drop/min at max vacuum	Drop/min air flow free air	g/h at max vacuum	g/h air flow free air
MEC 1000	20 - 25	10 - 12	50	25
MEC 1600	20 - 25	10 - 12	50	25
MEC 2000	25 - 30	12 - 15	63	32
MEC 3000	25 - 30	12 - 15	63	32
MEC 4000	25 - 30	12 - 15	63	32
MEC 5000	30 - 40	15 - 20	80	40
MEC 6500	40 - 50	20 - 25	100	50
MEC 8000	40 - 50	20 - 25	100	50
MEC 9000	50 - 60	25 - 30	120	60
MEC 11000	50 - 60	25 - 30	120	60
MEC 13500	50 - 60	25 - 30	120	60

MODEL	Drop/min for each drain cock at max vacuum	Drop/min for each drain air flow free air	g/h for each drain cock at max vacuum	g/h for each drain air flow free air
STAR 60	30 - 40	15 - 20	80	40
STAR 72	35 - 45	17 - 22	90	45
STAR 84	40 - 50	20 - 25	100	50
AGRI 60	30 - 40	15 - 20	80	40
AGRI 72	35 - 45	17 - 22	90	45
AGRI 84	40 - 50	20 - 25	100	50

Table 3



6.7 REGULATION FOR LUBRICATING OIL

To adjust the dripping of oil in the Rotary blades vacuum pump with forced lubrication, turn the regulator ring nut “A” (see Figure 8) after loosening ring nut “B”.

Tighten ring nut “B” again when adjustment has been completed.

The adjustment of oil delivery, in automatic lubrication, is carried out at our factory during final testing of the Rotary blades vacuum pump.

If, for any reason, a different setting is required proceed as follows: remove pin cover “B” (see Figure 9), loosen lock nut “C” and then turn regulator pin “A”.

By rotating clockwise lower oil delivery is obtained (-), and by rotating anticlockwise higher oil delivery is obtained (+). When adjustment has been completed tighten lock nut “C” and screw cover.

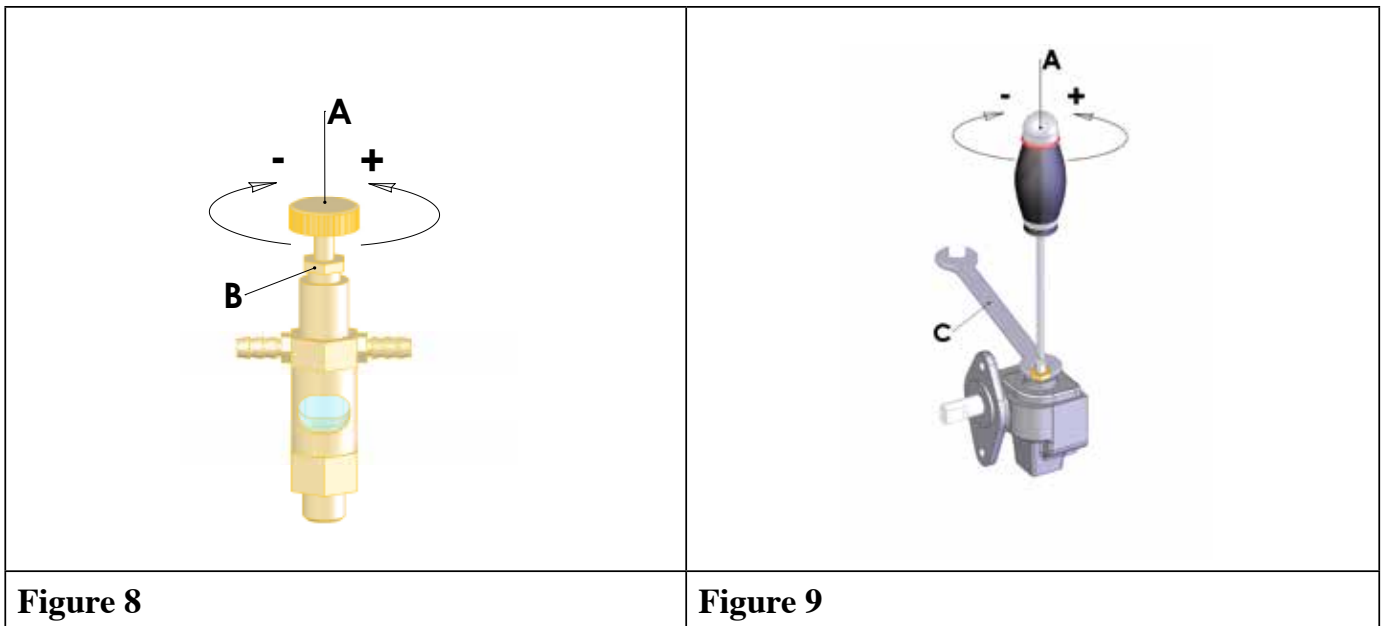

Figure 8

Figure 9

7 – OVERPRESSURE AND VACUUM ADJUSTMENT VALVES

The following diagram describes the valves as series (O), on demand (X) and not available (-) for each model of rotary blades vacuum pump.

	VACUUM ADJUSTMENT VALVE 1" 1/2	OVERPRESSURE VALVE 1" 1/4	OVERPRESSURE VALVE 1" 1/2	OVERPRESSURE VALVE 2"
MEC 1000/1600	-	-	-	-
MEC 2/3/4000	-	X	-	-
MEC 5/6.5/8000	X	-	X	-
MEC 9/11/13500	X	-	-	X
STAR 60/72/84	O	-	-	X
AGRI 60/72/84	O	-	-	X

O = As Series

X = on request

- = Not available

Table 4

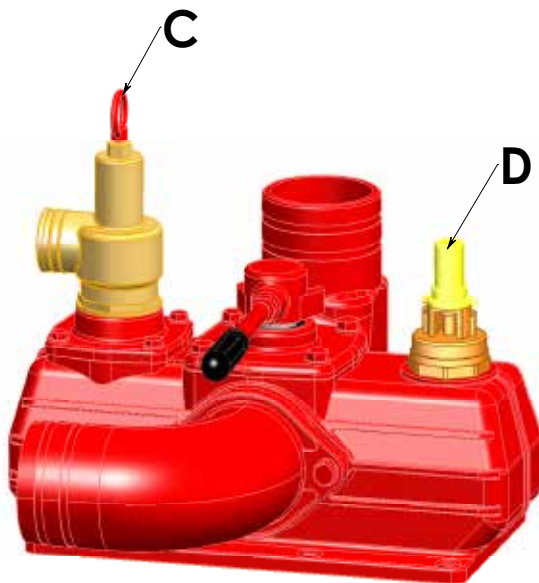

ATTENTION: the installation must be always equipped with depression valve (set at $-0,80$ bar) and with overpressure valve (set at 1 bar).

Pressure: the maximum allowed pressure is 2,5 absolute bar (1,5 relative bar). In order to avoid exceeding this value or to obtain a lower max pressure, an overpressure valve, "C", must be applied that is of a size capable of discharging the excess air delivery.

Vacuum: too high a vacuum may cause ovality and waviness of the body or breaking of the blades.

It is therefore advisable to use a vacuum regulator valve, "D". These valves may be fitted on the manifold cover or on manifold of the Rotary blades vacuum pump. Vacuum working degree is of $-0,80$ bar.

The regulation of the valves is done by acting on the throttle placed on the valve same (overpressure valve) or action on nut and locknut (vacuum adjustment valve).

Figure 10

8 - TESTING AND RUNNING IN

8.1 TESTING

All the Rotary blades vacuum pump Battioni Pagani are tested before the delivery at our plant.



In order to test the Rotary blades vacuum pump check the preceding points, using a workbench if necessary.

Make sure that the P.T.O. shaft turns freely and that the direction of rotation is the same as the one indicated by the arrow.



If operation of the pump is checked without it being connected to the suction/delivery tubes there will be danger to operators' hands due to access to the inside of the discharge elbow. In this situation there is also the danger that foreign bodies will be sucked into the machine.

Check that the position of the handle is correct and test that the Rotary blades vacuum pump exhausts or compresses.

8.2 RUNNING IN

The running in period foreseen for a rotary blades pump is of 30 of effective working. During that period the working parameters must be reduced of 20%



9 - START, OPERATION, STOP

9.1 START

The Rotary blades vacuum pump does not have a start button. Therefore to start it just transmit the motion to the power take-off (P.T.O.). The way this is done depends on the version of Rotary blades vacuum pump. Before starting make sure that the rotary blades vacuum pump is supplied with oil for internal lubrication (and lubrication of gearbox in versions .../M-MA and .../K-KA).



Before starting the rotary blades vacuum pump, make sure that the guards on all the moving parts are in place and efficient. Any damaged or missing components must be replaced and installed correctly before using the transmission.

For .../M-MA, K-KA, D version clean and grease the power take off before to install the cardan transmission.

9.2 OPERATION



Do not use the Rotary blades vacuum pump at pressures, temperatures, times higher than those indicated in Table 6. During use do not exceed the speed and power limits set in this manual. Do not overload the machine or suddenly engage the P.T.O.

Check the following operating parameters.

PARAMETER		WORKING RATE	MAXIMUM RATE
Revs M, K	[rpm]	450-500	600
Revs P, D, H,	[rpm]	1000	1200
Revs MA, KA	[rpm]	800	1000
Pressure	[bar]	0,5 – 1	1,5
Vacuum	[%]	80 %	95 %
Outside temperature side cylinder compression [°C]		80 – 90	130
Time	[min]	3-5	6-8
Working time with long life blades [min]		6-8	15
Working time ballast version –0,65 bar		continuous	continuous

Table 5



Failure to comply with the instructions given in this manual may be dangerous for the user health or may damage the rotary blades vacuum pump. If density of material to suck is high, dilute or mix the material same. The working time should be such that the maximum temperature is never reached. Prolonged operation without interruption may cause damage to the blades as well as overheating.

9.3 STOP

To stop the rotary blades vacuum pump, stop the engine and disconnect the P.T.O. in order to prevent accidental operation of it.

9.4 CONTROLS

A handle, located at the top of the manifold, is provided for the control of intake and compression phases. This can be operated manually. To state in which direction the handle has to be turned to select suction or compression phase, follow the instructions given by the manufacturer of the installation. If the reverse gear locks up, use a lever to lift the handle.



Selection of the intake or compression phase with the handle must be made with the Rotary blades vacuum pump not operating.

9.5 TEMPERATURE INDICATOR (THERMO TAPE)

Thermo Tape is affixed on the compression side of all Mec 9000-11000-13500 versions.

This temperature indicator provides two temperature readouts:

- The reversible scale at the bottom changes colour (from black to blue) at a specific temperature (90 ° C to 120 ° C). The scale is provided to help the user prevent the pump from overheating.
- A blue square with a white dot at the centre (a non-reversible indicator) is located at the upper right on the scale. If the dot turns black, the temperature has exceeded 160 ° C, which means the pump has been used for more than 15 minutes at its maximum vacuum level (which is an incorrect use). If this occurs, the pump must be disassembled and all the seals, oil seals and blades must be replaced.



9.6 PROTECTIVE DEVICES



The Rotary blades vacuum pump, when being installed on a machine, must be equipped with a protective device to isolate the moving parts and prevent access to them by the operators.



It is necessary to protect the Rotary blades vacuum pump to avoid the remote danger of material projection in case of heavy breakage.

.../M-MA, K, KA and D versions are equipped with a CE plastic protective device. It insulates and protects the P.T.O. shaft during moving.

9.7 INDIVIDUAL MEANS OF PROTECTION TO BE USED



When operating the Rotary blades vacuum pump, it is necessary to use the individual means of protection prescribed by the Manufacturer of the machine on which the Rotary blades vacuum pump has been installed.



10 - TROUBLESHOOTING

PROBLEM	CAUSE	REMEDY
Little vacuum or pressure	Blades are worn	Replace blades
	Some blades jammed in rotor	Disassemble rotary blades vacuum pump, clean and wash rotor, blades, and body
	Air infiltration or leakage from system	Eliminate infiltrations
	Undulated cylinder	Smooth or replace the body
	Reversing gear badly positioned	Remove reversing gear and position it correctly
	Flange assembly too tight	Add a gasket to the back flange
Overheating	Excessive pressure	Reduce pressure
	Excessive rate of revs	Reduce rate of revs
	Excessive operating time	Reduce operating time
	Blades too long	Trim blades to correct size
	Lack of lubrication	Check oil level in tank, oil pump operation, setting of oil tap
Beating against external surface	Rate of revs too low	Increase rate of revs
	Excessive/short and/or not suitable lubrication oil	Clean the rotary blades pump and replace the oil
Sewage comes out of discharge elbow	Malfunctioning of valves	Check valves
Smoke comes out of discharge elbow	Excessive lubrication	Adjust lubrication
No circulation of lubricating oil (for versions with automatic lubrication)	Air intake at pipe fittings	Replace pipe fittings
	Lubrication tube badly inserted in pipe fittings	Insert lubrication tube correctly
	Air in oil pump chamber	Fill pump chamber with oil
P.T.O. does not rotate	Broken blades	Replace blades (check if rotor pin is bent)
	Foreign body in rotary blades vacuum pump	Remove foreign body
No suction / no compression	Handle incorrectly positioned	Position handle correctly
	Reversing gear incorrectly positioned	Position reversing gear correctly
	Rotary blades vacuum pump rotates in wrong direction	Reverse direction of rotation
	All blades jammed	Disassemble rotary blades vacuum pump, clean and wash blades, rotor and body
	Blades protrude from the rotor slots anomalously	Disassemble rotary blades vacuum pump, clean and wash blades, rotor and body
	Rubber ball closes overflow valve	Increase passage of air inside valve

11 - MAINTENANCE, INSPECTIONS AND CHECKS, REPAIRS, TECHNICAL ASSISTANCE



When carrying out maintenance operations, inspections, checks or repairs it is advisable to wear the individual protective devices listed in this manual.



All maintenance operations, inspections, checks and repairs must be carried out with the greatest care and with the Rotary blades vacuum pump off and the P.T.O. disconnected.

11.1 CLEANING

11.1.1 WASHING OF THE BODY

If sewage enters the Rotary blades vacuum pump, the inside of the body must be washed immediately, by making it suck in diesel or fuel oil through the discharge elbow with the Rotary blades vacuum pump in compression phase. After this operation make it suck in oil. The same operation should be carried out when the Rotary blades vacuum pump has to remain inactive for a long time. In this case, disconnect the suction and delivery tube connected to the valves and hermetically seal the manifold cover because the gasses that form inside the tank would pass into the Rotary blades vacuum pump and cause the inside of the body to rust and this in turn could cause the blades to break when the system is re-started.

In order to avoid rust formation, do not use water.

If the body is washed after it is disassembled, it is advisable to carry out a preliminary wash with detergents (e.g. thinners) before carrying out the above operation.

11.1.2 WASHING OF OIL TANK

Wash the oil tank at least once a year. Remove the manifold, and then wash it using solvents.

11.1.3 WASHING AND CLEANING OF VALVES

Wash and clean the valves at least once a month. Remove the valves, then wash them with water or, if necessary, non-corrosive detergents.

11.2 CHECKING OF VALVES

Regularly check that all the valves, for both overflow and pressure/vacuum, are still working efficiently.

11.3 INSPECTION AND REPLACEMENT OF Blades

11.3.1 GENERAL INFORMATION ON BLADES

Three material type of blades are fitted on Rotary blades vacuum pump. The following Tabella 8 describes what kind of material is fitted for each series.

SERIES	STANDARD Blades	SPECIAL Blades
MEC 1000/8000	O	X
MEC 9/11/13500	-	O
STAR	O	X
AGRI	-	O

O = As series

X = On request

- = Not available

Table 8



Standard blades are suitable for no-strong uses, for short and not frequent periods.

Special blades are made of a special material suitable for strong uses and for Rotary blades vacuum pump used in agricultural field. These blades offer an excellent resistance to wear and mechanical and thermal stress. These are suitable for more frequent uses and to suck thick sewages. They are recommended for installation with frequent uses even during the same day.

Apart from normal wear, it may be necessary to replace the blades following incorrect use of the Rotary blades vacuum pump. The most frequent causes come from heat, lack of lubrication, entrance of sewage, high pressure or vacuum, formation of rust inside the body due to prolonged inactivity.

With the heat too high pallets stretch to touch the plate front and rear, this causes the breakdown of the pallets.

Lack of lubrication means the blades are completely dry like the inside of the pump. This increases their fragility and causes them to break lengthways.

The same type of breakage can be caused by entrance of sewage or by a too high working pressure.

A too high vacuum causes the blades to beat against the cylinder with consequent damage to the outside of the blades. Moreover, the lining becomes wavy.

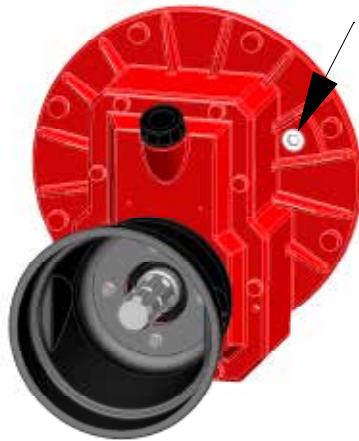

Figure 11

11.3.2 INSPECTION OF BLADES MEC/STAR/AGRI

To check the state of wear of the blades in the Rotary blades vacuum pump proceed as follows:

- Remove the threaded inspection plug;
- Rotate the rotor until a blades lines up with the inspection hole;
- Compare the height of the blades with the reference ring on the rotor;
- Replace the entire set of blades when the height is less than the reference ring on the rotor.



11.3.3 REPLACEMENT OF BLADES

- 1) Check that there is sufficient space at the back of the Rotary blades vacuum pump to be able to work easily; if there is not, the Rotary blades vacuum pump should be taken off its support beforehand;
- 2) Remove the back
- 3) Extract the blades from the rotor;
- 4) Replace the blades;
- 5) Clean the Rotary blades vacuum pump.
- 6) Re-fit the back of the Rotary blades vacuum pump
- 7) Use original spare parts Battioni Pagani® only



Ask for Rebuild kit for rotary blades vacuum pump which is made of: original Battioni Pagani® blades, gaskets, oilseals in one blister only.

11.3.4 BLADES SIZES

MODEL	Blades NUMBER	Blades SIZE
MEC 1000	5	120x38x6,5
MEC 1600	5	190x38x6,5
MEC 2000	7	180x41x6,5
MEC 3000	7	240x41x6,5
MEC 4000	7	300x41x6,5
MEC 5000	7	300x46,5x6,5
MEC 6500	7	370x46,5x6,5
MEC 8000	7	450x46,5x6,5
MEC 5000 S.C.	5	299x46,5x9,7
MEC 6500 S.C.	5	369x46,5x9,7
MEC 8000 S.C.	5	449x46,5x9,7

MODEL	Blades NUMBER	Blades SIZE
MEC 9000	5	300x60x6,5
MEC 11000	5	370x60x6,5
MEC 13500	5	460x60x6,5
MEC 9000 S.C.	5	299x60x9,7
MEC 11000 S.C.	5	369x60x9,7
MEC 13500 S.C.	5	459x60x9,7
MEC 9000 ballast	8	300x60x6,5
MEC 11000 ballast	8	370x60x6,5
MEC 13500 ballast	8	460x60x6,5
STAR 60	6	350x70x7,5
STAR 72	6	400x70x7,5
STAR 84	6	480x70x7,5
AGRI 60	6	350x70x4,7
AGRI 72	6	400x70x4,7
AGRI 84	6	480x70x4,7

Table 9



IMPORTANT: check that blades received as spare parts have a length lower or equal to nominal measure stated under our Table 9

11.4 REPLACEMENT OF RUBBER BALL

1. Unscrew and raise the valve-holder cover (AGRI and STAR series) or the manifold (MEC series);
2. Replace the rubber ball;
3. Re-fit the valve-holder cover (AGRI and STAR series) or the manifold (MEC series).

11.5 REPLACEMENT OF GEARS (version /M - MA and /K - KA)

1. Unscrew the screws of the gearbox cover;
2. Use two screws for screwing into the threaded extraction holes until the cover is removed;
3. Take out the gear with splined shaft using an extractor if necessary;
4. For the pinion: unscrew the self-locking nut, use an extractor.



11.6 TECHNICAL ASSISTANCE

Contact the supplier of the complete system for technical assistance or supply of accessories and spare parts.

11.7 REGULAR SERVICING

SERVICING TO BE CARRIED OUT	HOW TO PROCEED	FREQUENCY
Check oil circulation	Inspect the level sight glasses	Once a day
Check oil level in tank	Use the oil level on outside of tank	Once a week
Check wear of blades	Remove threaded plug	Every 300 working hours
Check that the over-pressure and vacuum regulator valves are working correctly	Remove valves	Once a week
Wash oil tank	Remove tank	Once a year
Wash body internally	Put in oil + diesel oil (after washing lubricate with oil only)	Whenever sewage enters or when inactive for a long time
Wash lubrication pump	Use a brush and compressed air	Once a year or for prolonged inactivity
Check that the overflow valves are working correctly	Remove valves	Once a month
Lubricate the power take-off (versions M - MA - K - KA and D)	Oil the P.T.O. with a brush and lubricating oil	Once a month
Wash and clean the valves	Remove valves	Once a month

12 - PUTTING OUT OF SERVICE AND DEMOLITION

Before demolishing the Rotary blades vacuum pump the following materials should be separated:

- lubricating oil;
- parts in rubber and plastic;
- parts in cast iron and steel;

and disposed of correctly.

Do not discard the Rotary blades vacuum pump in the environment.

For disposal of the lubricating oil make use of specialised treatment services.