

Applications: Compact screen filters with automatic back flushing

Standard Characteristics:

- **Filter element:** - Stainless Steel screen AISI 316, supported by a PVC cylinder.
- **Available filtration grades:** 80 - 3000 microns
- **Filter housing material of construction:** Carbon Steel ST37.2
- **Pre-treatment:** sand blasting up to Sa 2.5 grade
- **Exterior & Interior coating:** electrostatic oven baked polyester-epoxy powder coating with a thickness of 150-200 micron
- **Connections:** Victaulic, Threaded socket and Flange
- **Maximum recommended working pressure:** up to 10 bar (145 psi).
- **Minimum operating working pressure during flushing:** 2 bar (28.4 psi)
- Equipped with an electronic control system (6V DC, 12 V DC, 24V AC)

Operation:

Cleaning of the screen is performed automatically once the pressure loss (ΔP) across the filter has reached the preset value up to 0.5 bar (7psi). The flushing valve opens, pressure is released from the hydraulic piston, and debris laden water is discharged through the flushing valve. Pressure in the hydraulic motor chamber and the dirt collector is significantly lowered causing the dirt collector nozzles move along and rotate cleanings the whole internal screen surface. The flushing cycle takes 5 seconds. The flushing valve closes at the end of the cycle, pressure reapplied to the piston, moving the nozzles back to their rest position, and the filter is cleaned. During the whole process water supply is uninterrupted.



AUTOMATIC HYDRAULIC FILTERS – Series AF200

Model	In/Out ØD (mm) (in)		ØD1 (in)	X (mm) (in)		X1 (mm) (in)		Y (mm) (in)		H (mm) (in)		H1 (mm) (in)		Shipping Weight (kg) (lb)		Packing Volume L*W*H (m) (ft)	
AF202	50	2	10	220	8.7	465	18.3	197	7.8	507	19.9	475	18.7	43	95	0.6x0.6x0.8	1.9x1.9x2.5
AF202X	50	2	10	220	8.7	465	18.3	197	8.7	623	24.5	590	23.2	47	103	0.6x0.6x0.9	1.9x1.9x2.9
AF203	75	3	10	220	8.7	465	18.3	197	8.7	507	19.9	475	18.7	45	95	0.6x0.6x0.8	1.9x1.9x2.5
AF203X	75	3	10	220	8.7	465	18.3	210	8.3	641	25.2	590	23.2	48	105	0.6x0.6x0.9	1.9x1.9x2.9
AF204	100	4	10	220	8.7	465	18.3	210	8.3	641	25.2	610	24.0	50	110	0.6x0.6x0.9	1.9x1.9x2.9
AF204X	100	4	10	220	8.7	585	23.0	315	12.4	920	36.2	1145	45.1	70	154	0.7x0.7x1.2	2.2x2.2x4.0
AF206	150	6	10	220	8.7	585	23.0	400	15.8	1150	45.3	1575	62.0	90	198	0.7x0.7x1.4	2.2x2.2x4.3
AF208	200	8	16	303	11.9	642	25.3	450	17.7	1219	48.0	1700	66.9	150	331	0.8x0.8x1.4	2.9x2.7x4.7

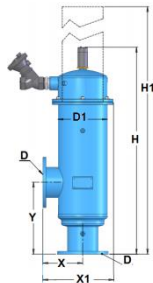

AUTOMATIC HYDRAULIC FILTERS – Series AF200

Pressure loss at 120 micron

Model	In/Out ØD		Max. Flow rate		Screen Area		Flushing Flow rate		Flushing Vol. (5 sec)	
	(mm)	(in)	(m ³ /h)	(gpm)	(cm ²)	(in ²)	(m ³ /h)	(gpm)	(m ³)	(gal)
AF202	50	2	30	132	1100	170	6	26	0.0083	2.20
AF202X	50	2	30	132	1630	253	6	26	0.0083	2.20
AF203	75	3	40	176	1100	170	6	26	0.0083	2.20
AF203X	75	3	50	220	1630	253	6	26	0.0083	2.20
AF204	100	4	80	352	1630	253	6	26	0.0083	2.20
AF204X	100	4	90	396	2770	430	20	87	0.0278	7.34
AF206	150	6	130	572	4120	640	20	87	0.0278	7.34
AF208	200	8	200	880	5240	812	20	87	0.0278	7.34

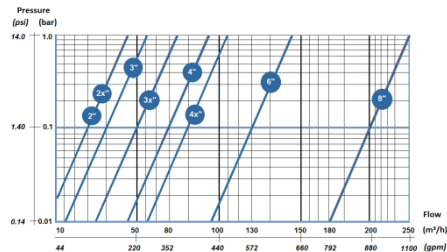

* Maximum recommended Flow Rate - 120 micron in good quality water

AUTOMATIC HYDRAULIC FILTERS – Series AF200

Maximum Flow (m³/h)

	Water quality	AF-202 2"	AF-202X 2"X	AF-203 3"	AF-203X 3"X	AF-204 4"	AF-204X 4"X	AF-206 6"	AF-208 8"
200μ	Good	25	30	40	50	80	90	130	200
	Regular	20	25	35	45	70	80	90	170
	Bad	15	20	25	35	40	50	70	130
100-150μ	Good	25	30	40	50	80	90	130	200
	Regular	15	20	25	35	40	50	70	150
	Bad	10	15	20	25	35	45	60	120

Water quality	ppm = mg/l
Good	< 15
Regular	15 – 50
Bad	50 – 100

AUTOMATIC HYDRAULIC FILTERS – Series AF200

AF200-DC Control System Setup

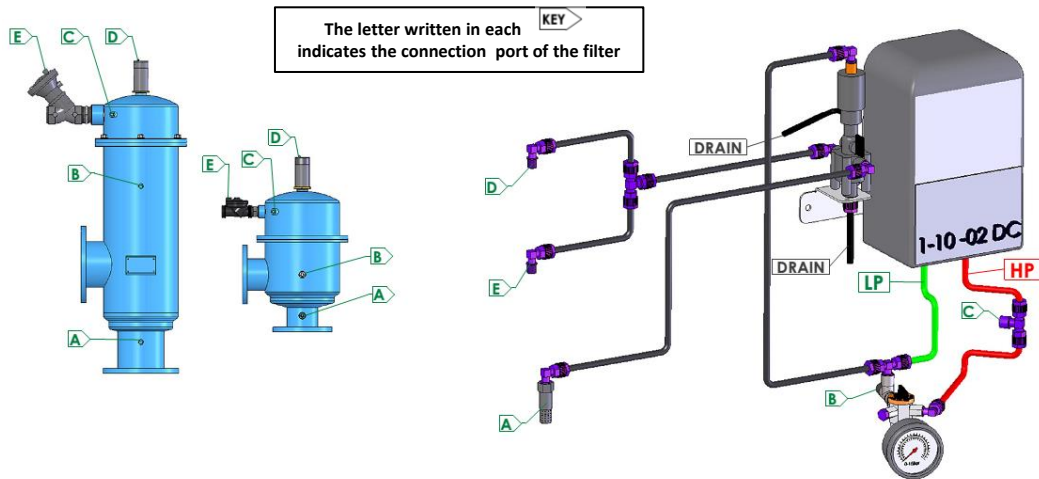

AUTOMATIC HYDRAULIC FILTERS – Series AF200

The letter written in each  KEY indicates the connection port of the filter

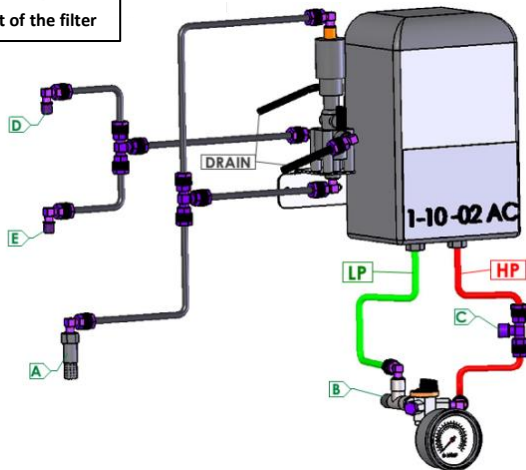
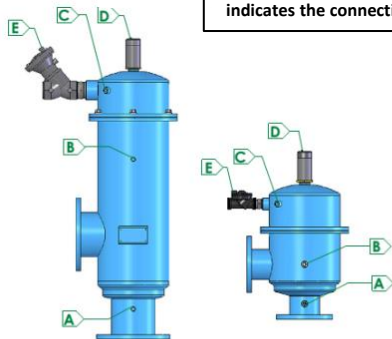

AUTOMATIC HYDRAULIC FILTERS – Series AF200

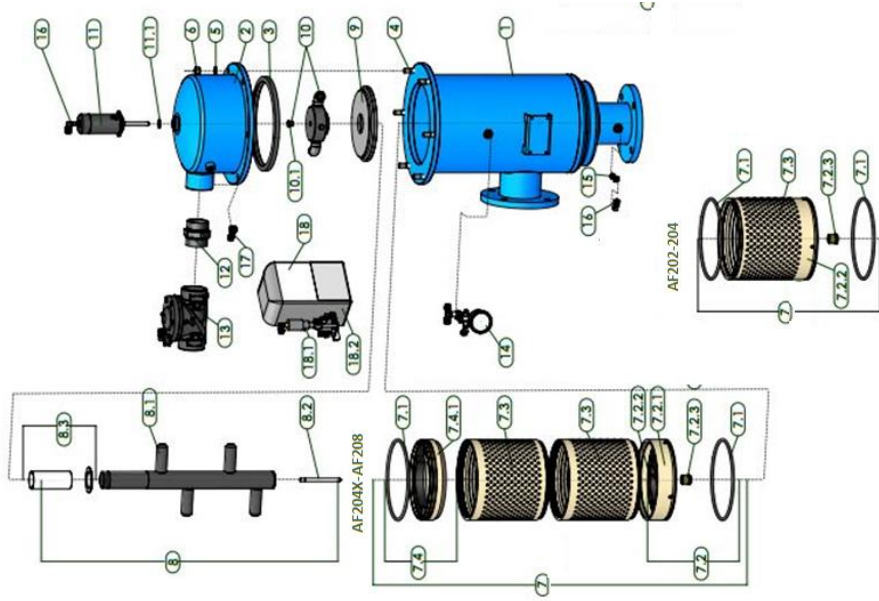

AUTOMATIC HYDRAULIC FILTERS – Series AF200

Part Breakdown		Filter Model			
FILTER		AF202 (2")	AF202X (2")	AF203 (3")	AF203X (3")
1	Filter body	N/A	N/A	N/A	N/A
2	Filter cover	N/A	N/A	N/A	N/A
3	U-Ring for cover	5311250100	5311250100	5311250100	5311250100
4	Stud	5292143001-043	5292143001-043	5292143001-043	5292143001-043
5	Washer	4121123001	4121123001	4121123001	4121123001
6	Nut	4112140401	4112140401	4112140401	4112140401
7	Fine screen	E7005601000-01##	E7005601001-01##	E7005601000-01##	E7005601001-01##
7.1	O-Ring	4081202100-445	4081202100-445	4081202100-445	4081202100-445
7.2.2	Screen wheel	5021640500	5021640500	5021640500	5021640500
7.2.3	Screen bearing f/dirt collec	5172391000	5172391000	5172391000	5172391000
7.3	Fine screen	W5005600400-01##	W5005600401-01##	W5005600400-01##	W5005600401-01##
8	Dirt collector	E7101610200-01	E7101610201-01	E7101610200-01	E7101610201-01
8.1	Suction nozzle	5121610101	5121610101	5121610101	5121610101
8.2	Dirt collector shaft	5131300900	5131300901	5131300900	5131300901
8.3	Dirt collector sleeve	5171303301	5171303302	5171303301	5171303302
9	Flushing chamber	E5023010500-01	E5023010500-01	E5023010500-01	E5023010500-01

AUTOMATIC HYDRAULIC FILTERS – Series AF200

Part Breakdown		Filter Model			
FILTER		AF202 (2")	AF202X (2")	AF203 (3")	AF203X (3")
10	Hydraulic motor	E5141630200-01	E5141630200-01	E5141630200-01	E5141630200-01
10.1	Hydraulic motor bearing	5173360001	5173360001	5173360001	5173360001
11	Hydraulic piston*	E7160306300	E7160306302	E7160306300	E7160306302
11.1	O-Ring	4081020110	4081020110	4081020110	4081020110
12	Double nipple	4220106500	4220106500	4220106500	4220106500
13	Hydraulic valve	4510010004-1M	4510010004-1M	4510010004-1M	4510010004-1M
14	Pressure gauge	CS11010019	CS11010019	CS11010019	CS11010019
15	Finger filter	4470010000	4470010000	4470010000	4470010000
16	Elbow	4640618082	4640618082	4640618082	4640618082
17	Tee connector	4640214082	4640214082	4640214082	4640214082
18	Controller 1-10DC + Solenoid	CSD1100112100	CSD1100112100	CSD1100112100	CSD1100112100
18	Controller 1-10 AC + solenoid	CSA1100114100	CSA1100114100	CSA1100114100	CSA1100114100
18.1	Solenoid DC	4430010902	4430010902	4430010902	4430010902
18.1	Solenoid AC	4430030901	4430030901	4430030901	4430030901
18.2	Controller 1-10 DC	4440211002	4440211002	4440211002	4440211002
18.2	Controller 1-10 AC	4440311002	4440311002	4440311002	4440311002
18.2.1	Expansion card 1-10 DC contr.	4450110200	4450110200	4450110200	4450110200
18.2.1	Expansion card 1-10 AC contr	4450110300	4450110300	4450110300	4450110300

* See detail pg. 107

AUTOMATIC HYDRAULIC FILTERS – Series AF200

Part Breakdown		Filter Model			
FILTER		AF204 (4")	AF204X (4")	AF206 (6")	AF208 (8")
1	Filter body	N/A	N/A	N/A	N/A
2	Filter cover	N/A	N/A	N/A	N/A
3	U-Ring for cover	5311250100	5311250100	5311250100	5311400100
4	Stud	5292143001-043	5292143001-043	5292143001-043	5292143001-043
5	Washer	4121123001	4121123001	4121123001	4121123001
6	Nut	4112140401	4112140401	4112140401	4112140401
7	Fine screen	E7005601001-01##	E7005602001-01##	E7005603000-01##	E7006603000-01##
7.1	O-Ring	4081202100-445	4081202100-445	4081202100-445	4081266100-450
7.2	Upper screen adaptor		E5005600900-01	E5005600900-01	E5006600900-01
7.2.1	Upper screen adaptor		5005600900	5005600900	5006600900
7.2.2	Screen wheel	5021640500	5021640500	5021640500	5021010600-P
7.2.3	Screen bearing f/dirt collec	5172391000	5172391000	5172391000	5172391000
7.3	Fine screen	W5005600401-01##	W5005600300-01##	W5005600300-01##	W5006600300-01##
7.4	Lower screen adaptor		E5005601001-02	E5005601001-02	E5006601000-02
7.4.1	Lower screen adaptor		E5005601001-01	E5005601001-01	E5006601000-01
8	Dirt collector	E7101610201-01	E7102610400-01	E7102610600-01	E7102610601-01
8.1	Suction nozzle	5121610101	5121610201	5121610201	5121610202
8.2	Dirt collector shaft	5131300901	5131300901	5131300901	5131300902
8.3	Dirt collector sleeve	5171303302	5171305000	5171305000	E5171305001
9	Flushing chamber	E5023010500-01	E5023010501-01	E5023010501-01	E5023010600-01

AUTOMATIC HYDRAULIC FILTERS – Series AF200

Part Breakdown		Filter Model			
FILTER		AF204 (4")	AF204X (4")	AF206 (6")	AF208 (8")
10	Hydraulic motor	E5141630200-01	E5142610202-01	E5142610203-01	E5142610203-01
10.1	Hydraulic motor bearing	5173360001	5173360001	5173360001	5173360001
11	Hydraulic piston*	E7160306302	E7160306303	E7160306303	E7160306307
11.1	O-Ring	4081020110	4081020110	4081020110	4081020110
12	Double nipple	4220106500	4220200300	4220200300	4220200300
13	Hydraulic valve	4510010004-1M	4510020003-06-1M	4510020003-06-1M	4510020003-06-1M
14	Pressure gauge	CS11010019	CS11010019	CS11010019	CS11010019
15	Finger filter	4470010000	4470010000	4470010000	4470010000
16	Elbow	4640618082	4640618082	4640618082	4640618082
17	Tee connector	4640214082	4640214082	4640214082	4640214082
18	Controller 1-10DC + Solenoid	CSD1100112100	CSD1100112100	CSD1100112100	CSD1100112100
18	Controller 1-10 AC + solenoid	CSA1100114100	CSA1100114100	CSA1100114100	CSA1100114100
18.1	Solenoid DC	4430010902	4430010902	4430010902	4430010902
18.1	Solenoid AC	4430030901	4430030901	4430030901	4430030901
18.2	Controller 1-10 DC	4440211002	4440211002	4440211002	4440211002
18.2	Controller 1-10 AC	4440311002	4440311002	4440311002	4440311002
18.2.1	Expansion card 1-10 DC contr.	4450110200	4450110200	4450110200	4450110200
18.2.1	Expansion card 1-10 AC contr	4450110300	4450110300	4450110300	4450110300

* See detail pg. 107-108

AUTOMATIC HYDRAULIC FILTERS – Series AF200

Filter Model		AF202/203	AF202X/203X /204
Hydraulic Piston		E7160306300	E7160306302
1	Piston 30 cylinder	E5161633001-01	E5161633002-01
2	Piston 30 head	E5163633001-01	E5163633001-02
2.1	Piston 30 head	5163633001	5163633001
2.2	Axis for piston	5132301001	5132301002
2.3	U-Ring	4082020101	4082020101
3	Piston 30 adaptor	E5164393001-01	E5164393001-01
3.1	Piston 30 adaptor metal	5164393001	5164393001
3.2	Piston 30 washer	6143901001	6143901001
3.3	Internal retaining ring	4133263200	4133263200
3.4	O-Ring	4081020110	4081020110
3.5	U-ring	4082010100	4082010100
4	Male elbow plastic	4640618082	4640618082
5	Elbow steel	4650605001	4650605001

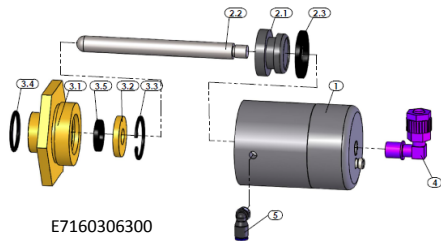

E7160306300
Model AF202/203

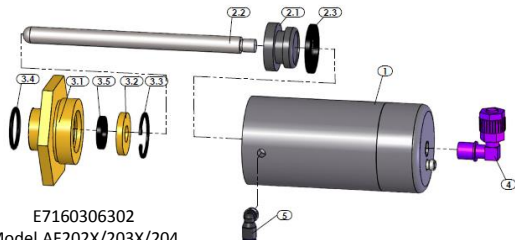

E7160306302
Model AF202X/203X/204